

CASIO®

SERVICE MANUAL & PARTS LIST

(without price)

LK-125

SEP. 2010

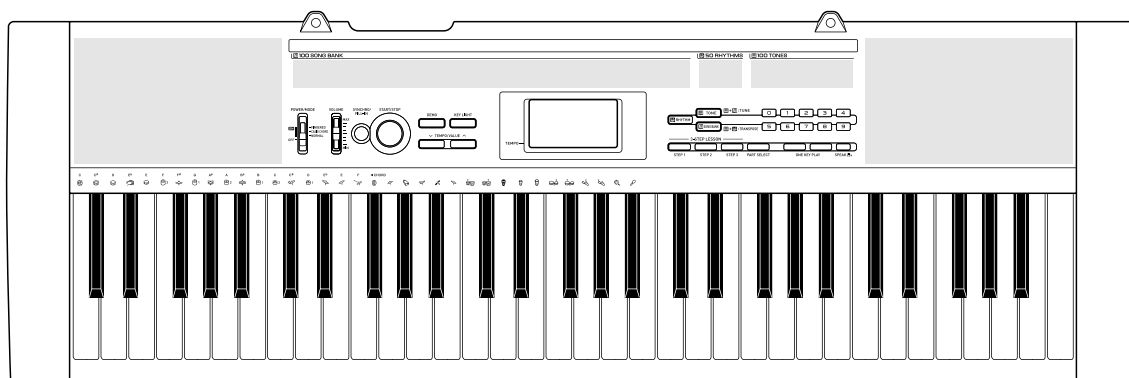

LK-125

ELECTRONIC KEYBOARD

Ver. 2 : Jan. 2012

CONTENTS

SPECIFICATIONS.....	1
BLOCK AND WIRING DIAGRAM	2
PCB INFORMATION	3
CIRCUIT DESCRIPTION	4
PRINTED CIRCUIT BOARDS.....	5
DISASSEMBLY	7
DIAGNOSTIC PROGRAM	16
EXPLODED VIEW.....	22
PARTS LIST	23
SCHEMATIC DIAGRAMS.....	26

SPECIFICATIONS

Keyboard	61 standard-size keys; 5 octaves
Key Light System	Can be turned on and off (up to 4 keys can be lit at the same time)
Tones	100 presets
Polyphony	12 notes maximum
3-Step Lesson System	Number of simultaneously lit keys; 4 3-Steps
Playback	1 tune repeat playback
Voice Fingering Guide	On/Off
Auto-accompaniment	
Rhythm Patterns	50 presets
Tempo	Adjustable, (216 steps, ♩ = 40 to 255), initial value; 120
Chords	Two systems; CASIO CHORD, FINGERED
Other	Fill-in pattern, Synchro start
Song Bank Tunes	100 tunes
Musical Information Function	Tone, Auto Accompaniment, Song Bank numbers and names; tempo, 3 step lesson display, chord name, fingering, timing indicator, key lighting, voice fingering
Other Functions	
Transpose	F# to C to F: half-note
Tuning	Adjustable A4 = Approx. 440 Hz ± 50 cents, Initial value: A4 = Approx. 440 Hz
Speakers	10 cm diameter × 2 (Output: 2 W + 2 W)
I/O Terminals	
Power Supply	DC 9.5 V jack
Headphones/Output	Stereo standard jack (Output is monaural.) Output impedance 78 Ω, output voltage: 4 V (RMS) MAX
Power Supply	2-way
Batteries	6 AA-size zinc-carbon batteries or alkaline batteries Battery Life: Approximately 4 hours continuous operation on alkaline batteries Approximately 1 hour continuous operation on zinc-carbon batteries
AC Adaptor	AD-E95100L
Auto Power Off	Approximately 6 minutes after the last operation
Power Consumption	9.5 V --- 7.7 W
Dimensions	94.9 × 30.4 × 9.3 cm (37 ³ / ₈ × 11 ¹⁵ / ₁₆ × 3 ¹¹ / ₁₆ inch)
Weight	Approximately 3.4 kg (7.5 lbs) (without batteries)

BLOCK AND WIRING DIAGRAM

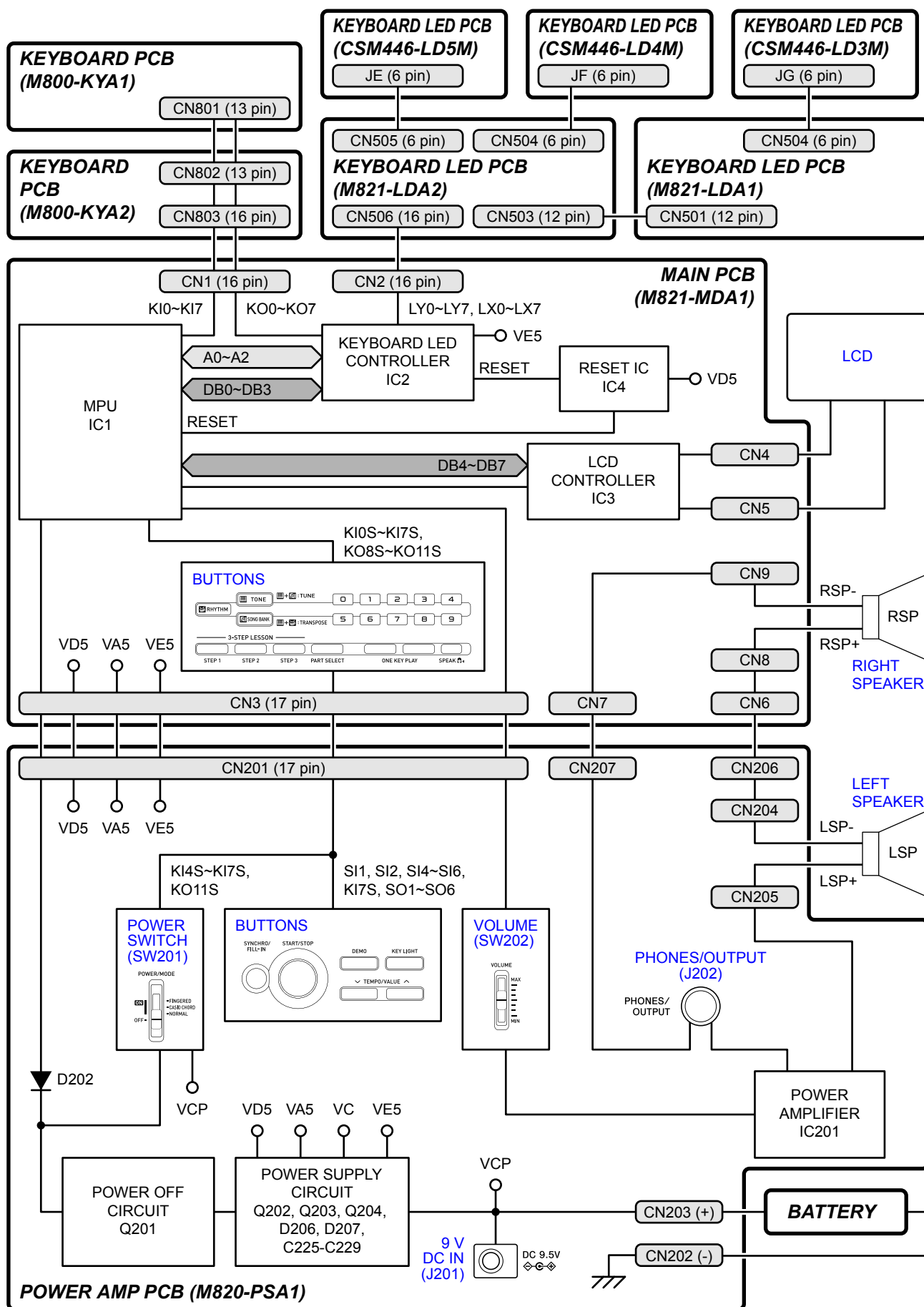

PCB INFORMATION

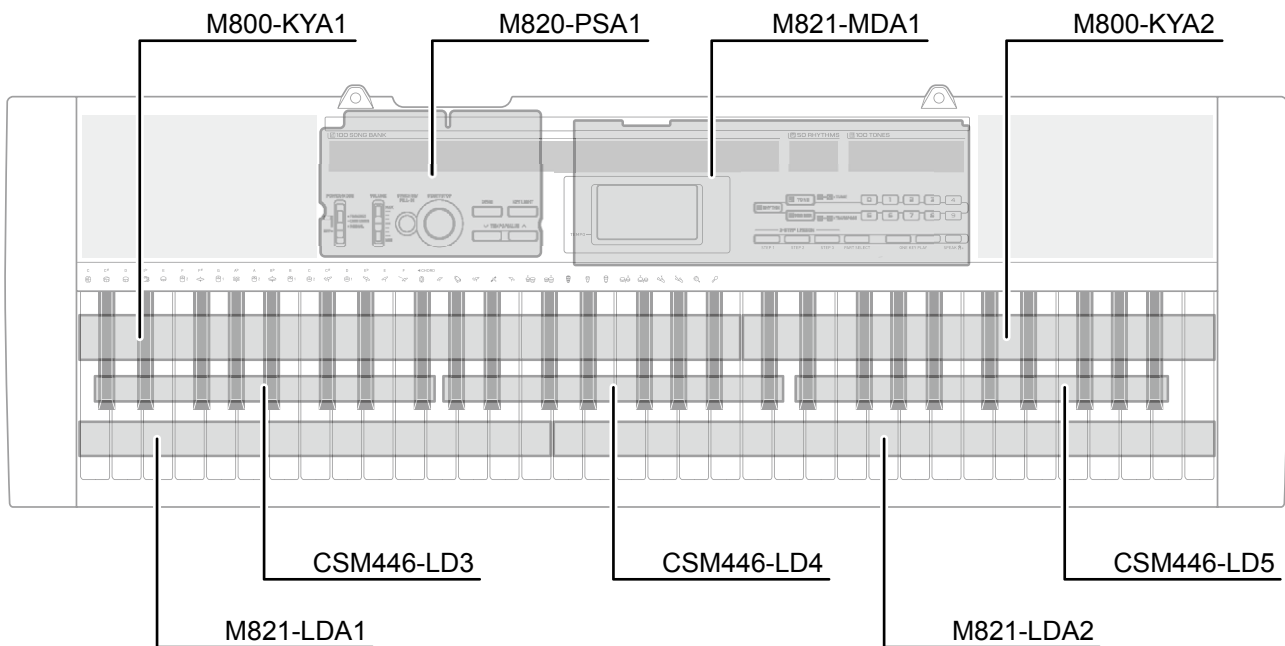

Classification	Parts Name	PCB Name	Components
Main PCB	PCB ASSY/MDA1	M821-MDA1	MPU, LCD Controller, Keyboard LED Controller, Reset IC, Buttons, Right Speaker Terminal
Power Amp PCB	PCB ASSY/PSA1	MX820-PSA1	Power Supply Circuit, Power Amplifier, Power Switch, Volume, Buttons, DC 9.5 V Jack, Left Speaker Terminal, Phones/Output Jack
Keyboard LED PCB	PCB ASSY/LDA	M821-LDA1	Keyboard LED
		M821-LDA2	
	PCB ASSY/LD3M	CSM446-LD3M	
	PCB ASSY/LD4M	CSM446-LD4M	
	PCB ASSY/LD5M	CSM446-LD5M	
Keyboard PCB	PCB ASSY/KYA	M800-KYA1	Keyboard
		M800-KYA2	

CIRCUIT DESCRIPTION

■ KEY MATRIX

	KC0	KC1	KC2	KC3	KC4	KC5	KC6	KC7
KI0	C2	C2#	D2	D2#	E2	F2	F2#	G2
KI1	G2#	A2	A2#	B2	C3	C3#	D3	D3#
KI2	E3	F3	F3#	G3	G3#	A3	A3#	B3
KI3	C4	C4#	D4	D4#	E4	F4	F4#	G4
KI4	G4#	A4	A4#	B4	C5	C5#	D5	D5#
KI5	E5	F5	F5#	G5	G5#	A5	A5#	B5
KI6	C6	C6#	D6	D6#	E6	F6	F6#	G6
KI7	G6#	A6	A6#	B6	C7			

■ NOMENCLATURE OF KEYS

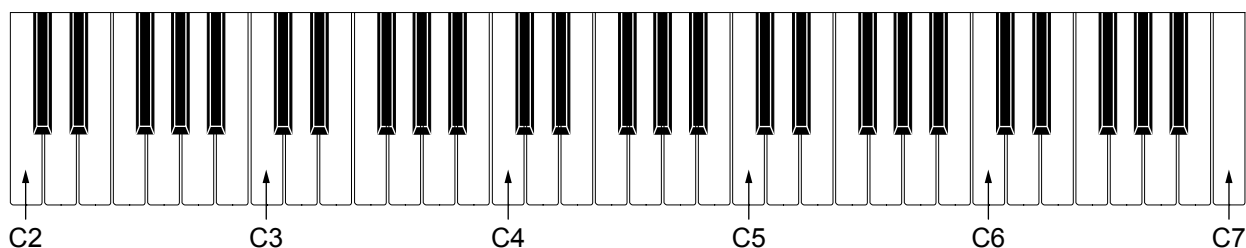

■ BUTTON MATRIX

	KO8S	KO9S	KO10S	KO11S
KI0S	0	5	TONE	STEP 1
KI1S	1	6	RHYTHM	STEP 2
KI2S	2	7	SONG BANK	STEP 3
KI3S	3	8	PART SELECT	SPEAK
KI4S	4	9	ONE KEY PLAY LEFT	FINGERED (POWER/MODE)
KI5S	START/STOP	TEMPO DOWN/ VALUE	ONE KEY PLAY RIGHT	CASIO CHORD (POWER/MODE)
KI6S	TEMPO UP/ VALUE		KEY LIGHT	NORMAL (POWER/MODE)
KI7S		SYNCHRO/ FILL-IN	DEMO	OFF (POWER/MODE)

PRINTED CIRCUIT BOARDS

Main PCB: M821-MDA1

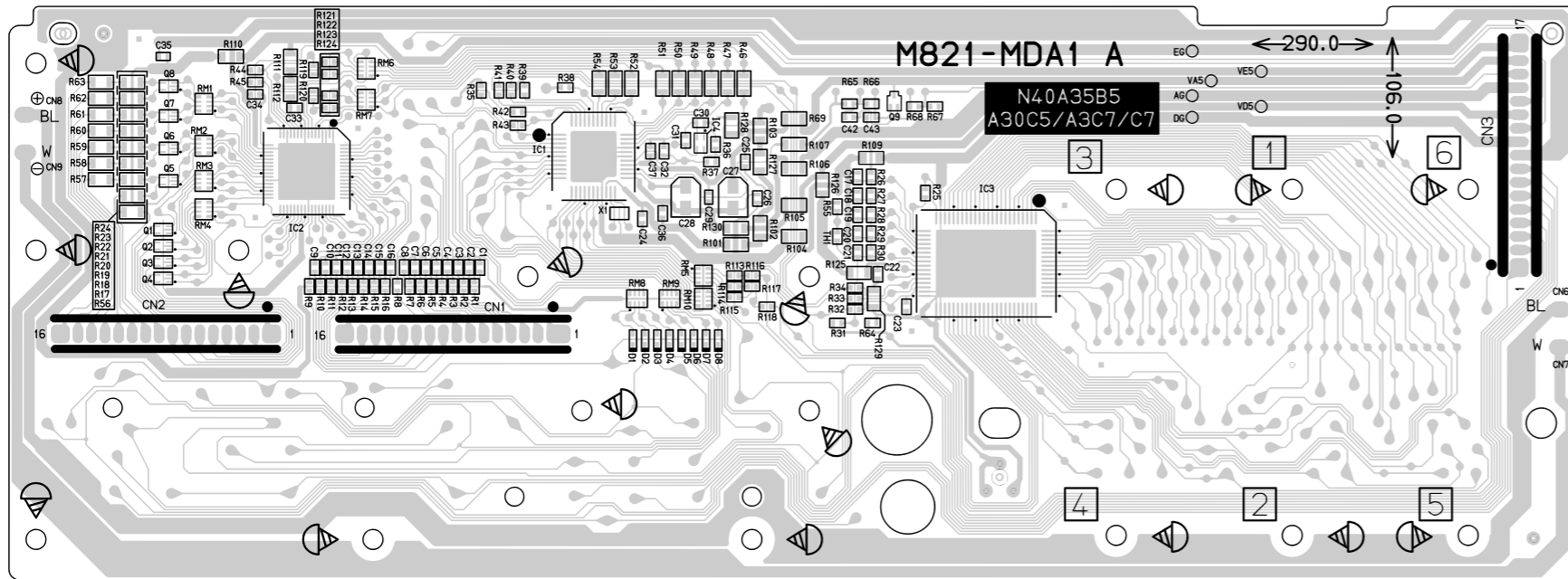

Power Amp PCB: M820-PSA1

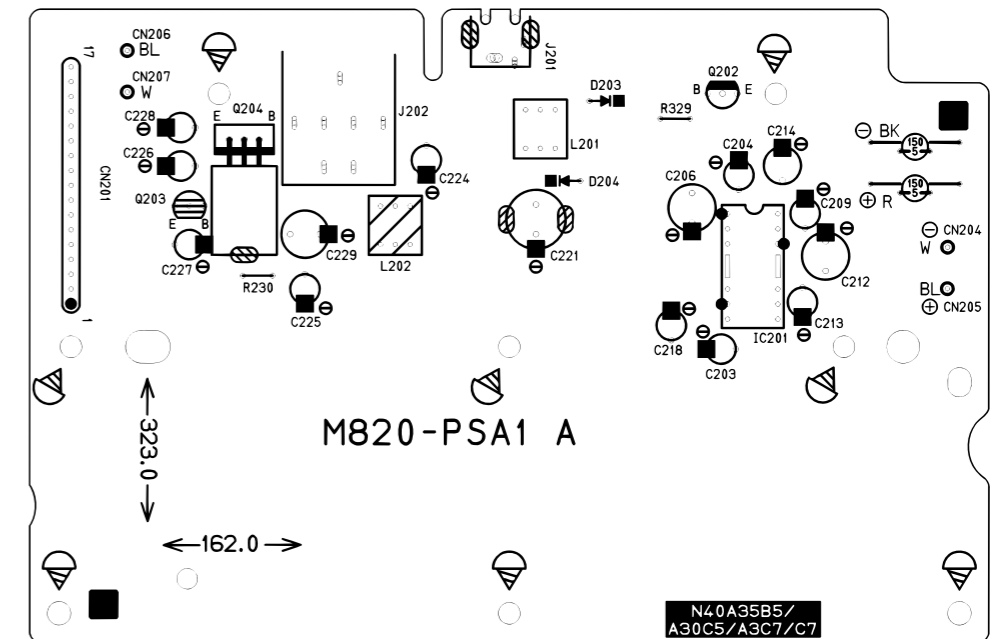
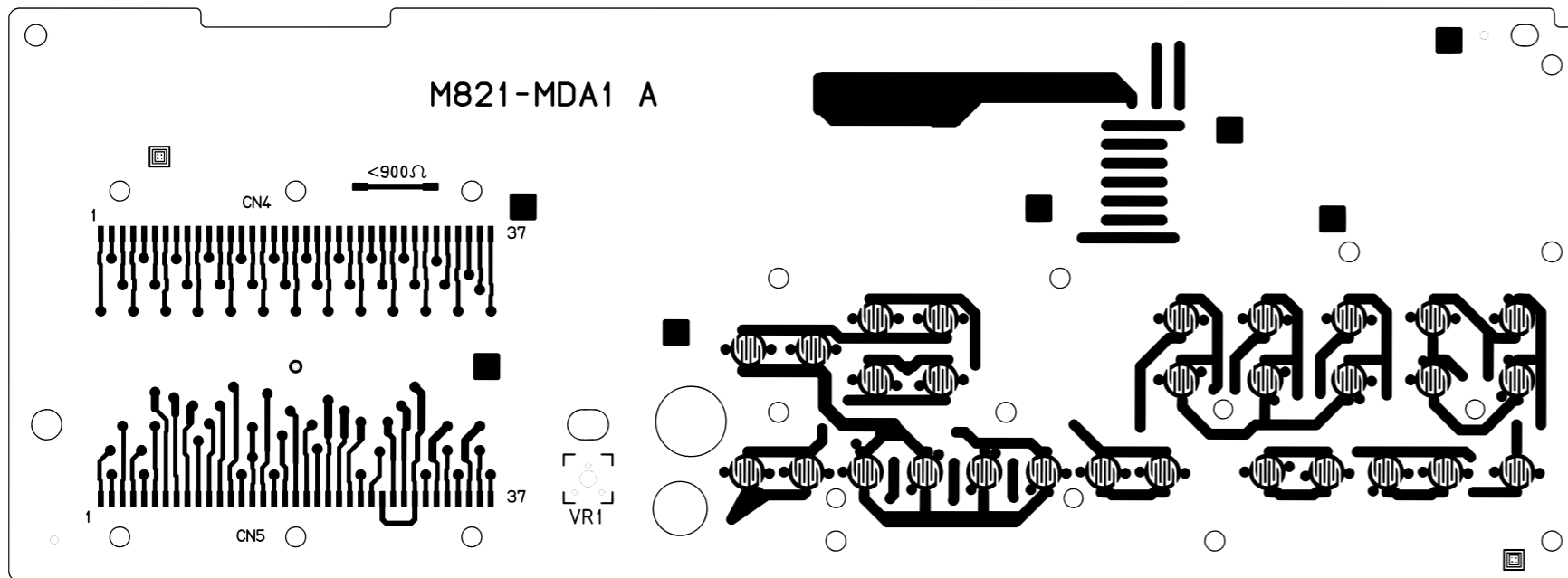
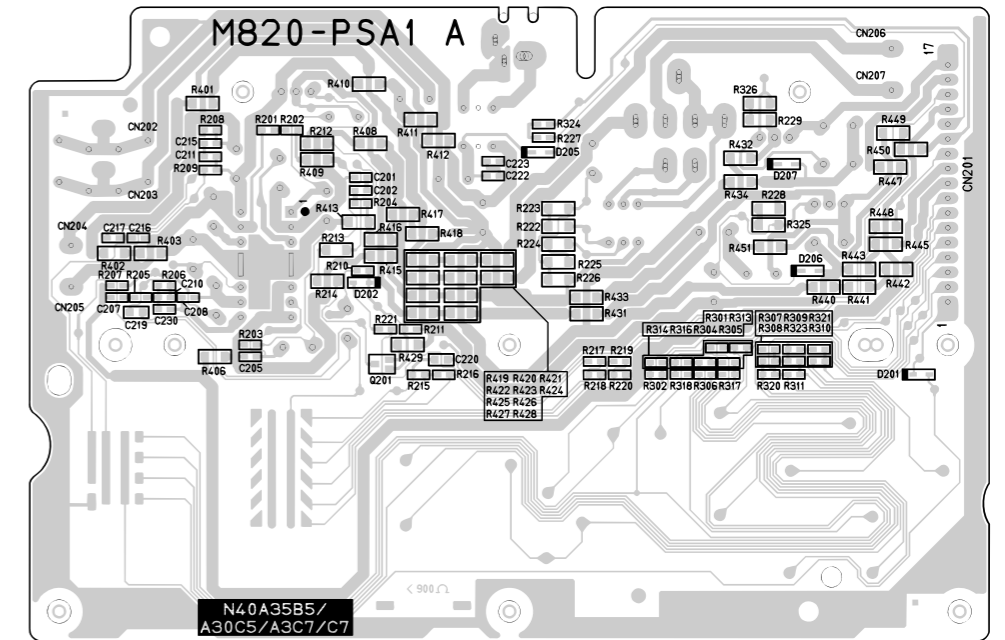

Keyboard LED PCB: M821-LDA1

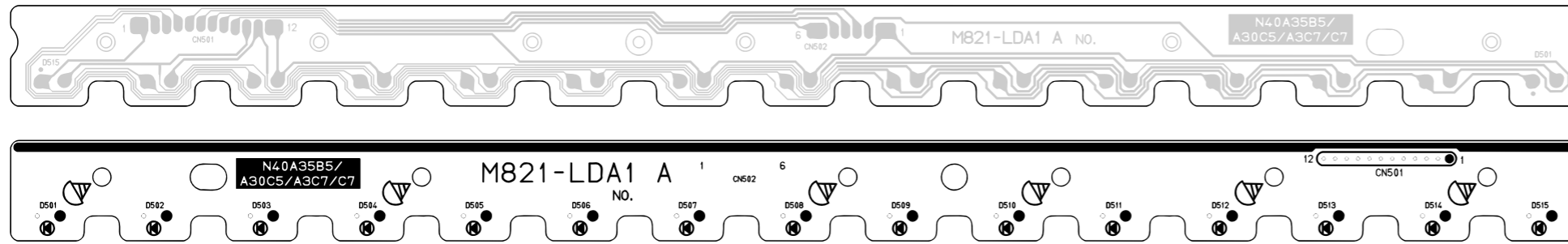

Keyboard LED PCB: M821-LDA1

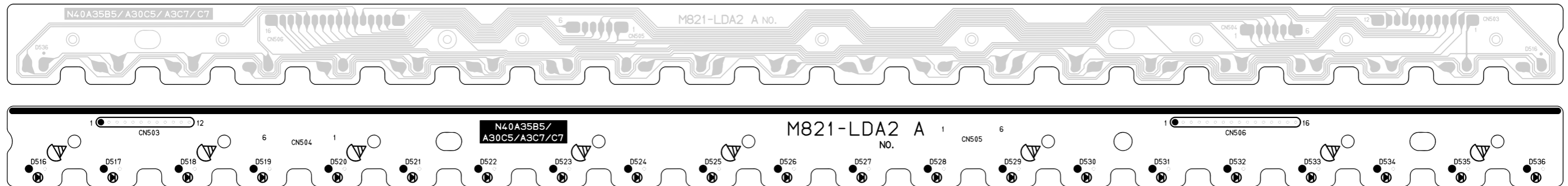

Keyboard PCB: M800-KYA1

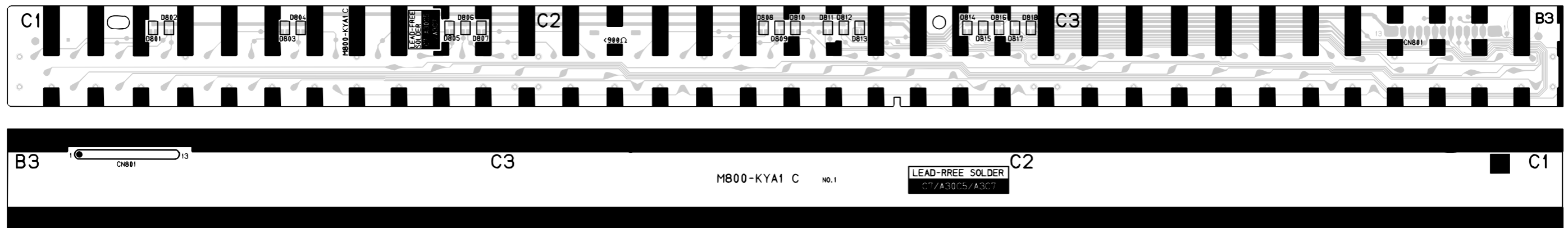

Keyboard PCB: M800-KYA2

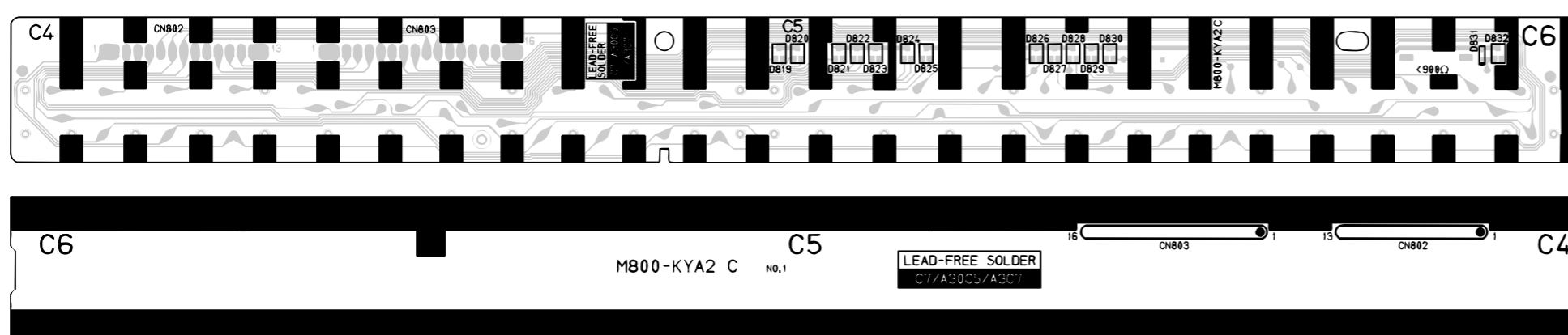

DISASSEMBLY

■ CAUTION

- The photos show a prototype. The appearance of the instrument, such as color, may differ from the actual model.
- To avoid damages to the instrument and the floor, lay the instrument on a mattress or blanket before starting disassembling.
- There are several kinds of screws. Be sure to use the correct type of screws when reassembling. It is advisable to sort the screws as shown below after removing them.

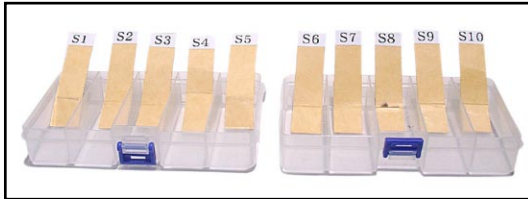

- If a screw cap is attached to a screw, be sure to reattach the screw cap when reassembling.

■ BEFORE STARTING REPAIR OR SERVICING

- Remove the AC adaptor or the AC cord.
- Remove accessories such as the music stand.

■ DISASSEMBLY

A. PANEL UNIT

A-1. Undo 11 screws on the bottom surface of the main unit

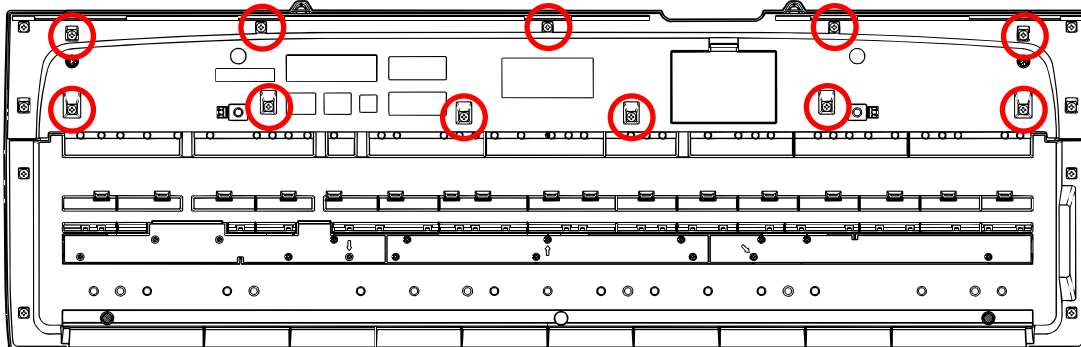

A-2. When replacing the keyboard LED PCBs, undo 16 screws and then remove the L-COVER-A/B/C.

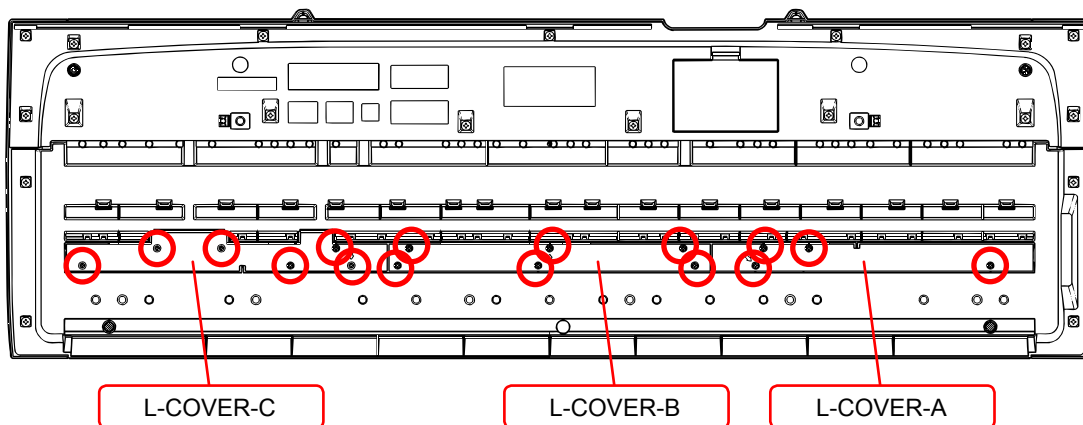

<Caution for installing L-COVER-A/B/C>

To install the L-COVER-A/B/C, tighten the screws indicated with arrows engraved on each cover first.

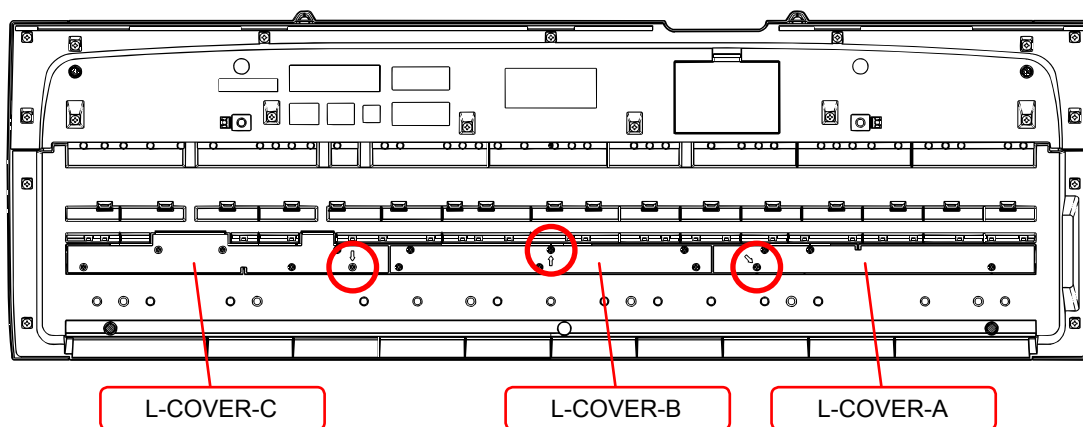

A-3. Turn over the panel unit.

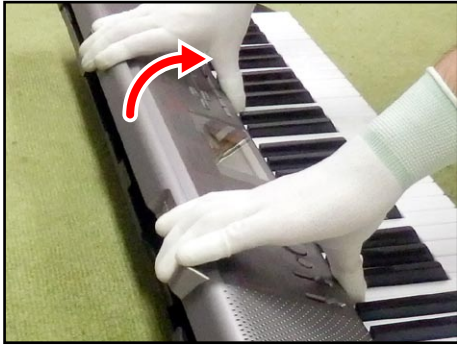

A-4. Unsolder two battery lead wires.

A-5. Unsolder two FFCs.

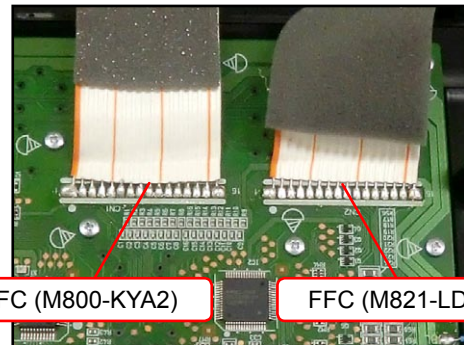
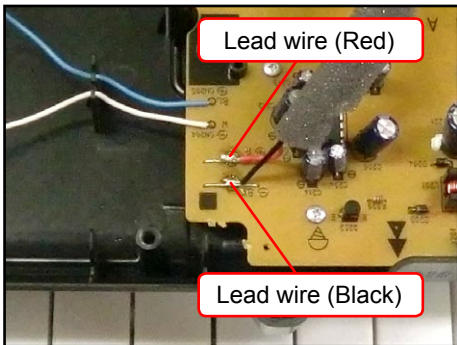

A-6. Remove the panel unit.

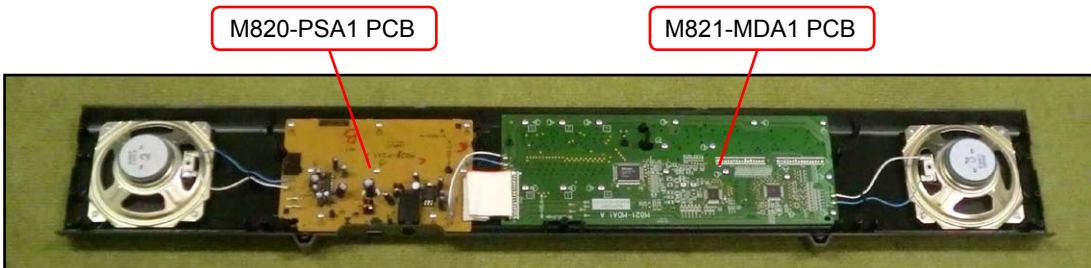

B. MAIN PCB (M821-MDA1)

B-1. Unsolder two FFCs.

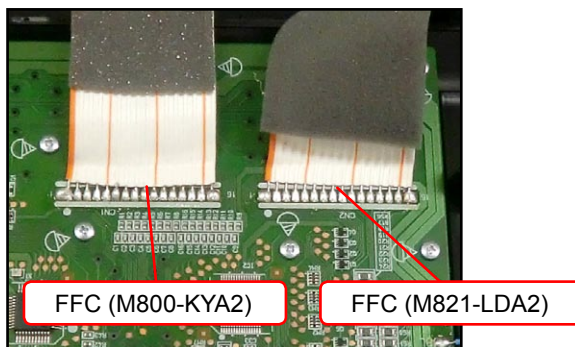

B-2. Unsolder two lead wires and one FFC.

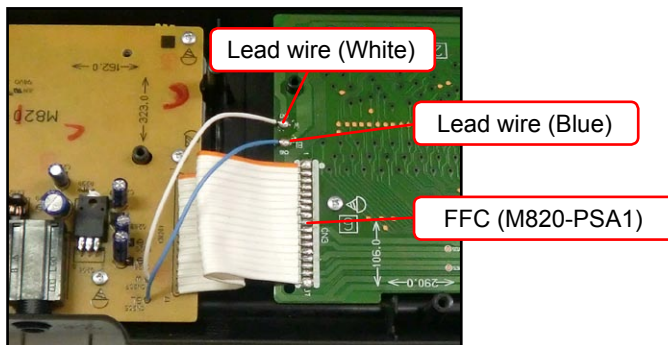

B-3. Unsolder two lead wires connected to the right speaker.

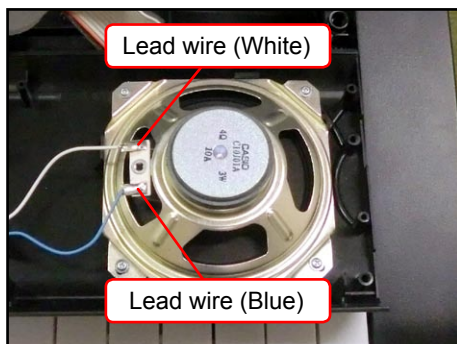

B-4. Undo 16 screws and then remove the M821-MDA1 PCB, rubber keys and LCD.

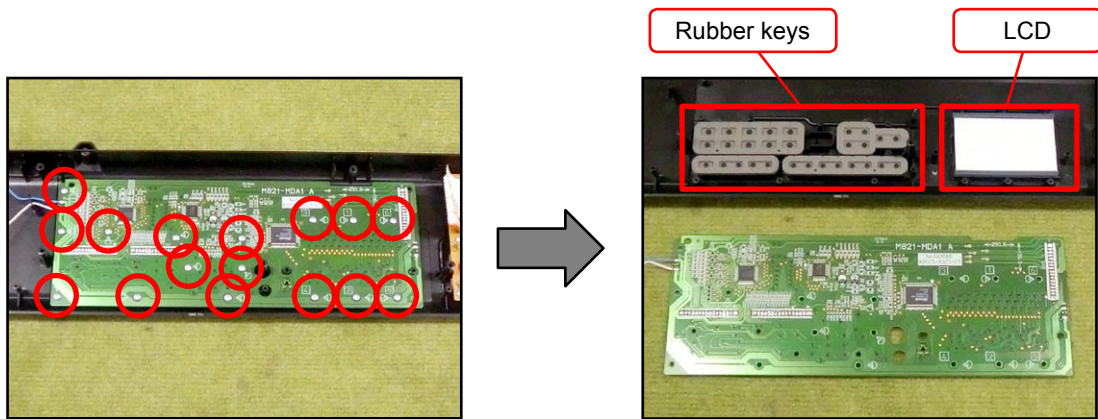

<Caution for installing M821-MDA1 PCB>

To install the M821-MDA1 PCB, tighten the screws for the LCD part in the order shown in the right. If not tighten correctly, it may cause the LCD display errors.

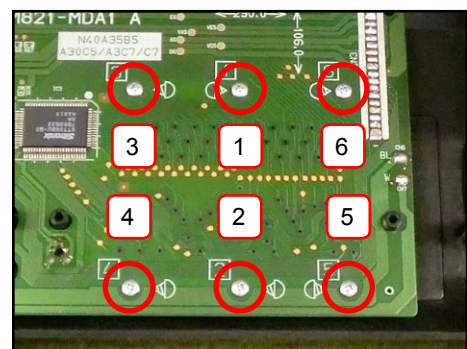

C. POWER AMP PCB (M820-PSA1)

C-1. Unsolder two lead wires and one FFC connected to the M821-MDA1 PCB.

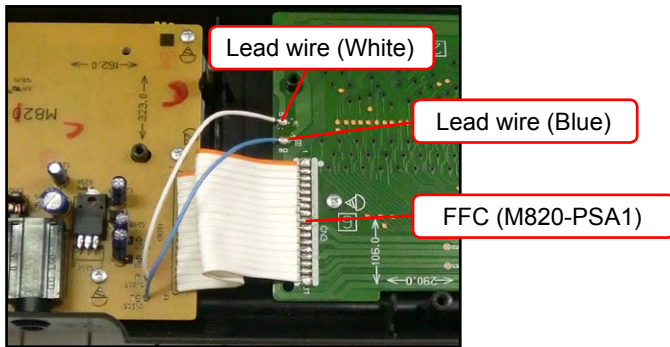

C-2. Unsolder two lead wires connected to the left speaker.

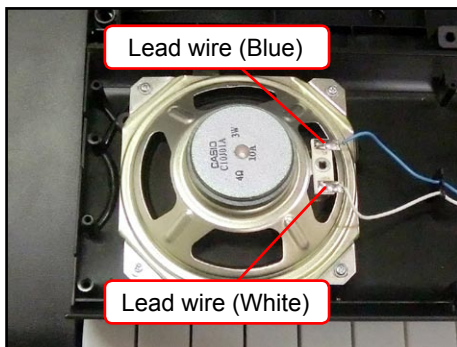

C-3. Undo eight screws and then remove the M820-PSA1 PCB, rubber keys and switches.

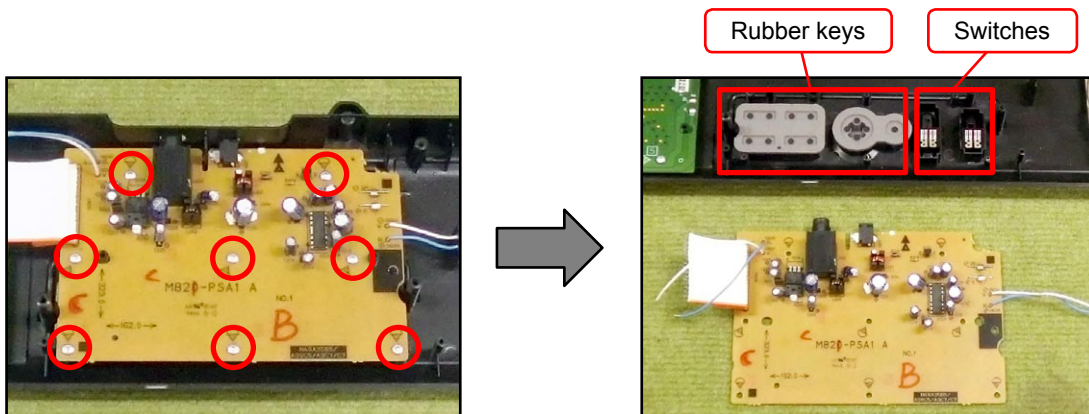

D. KEYBOARD

D-1. Undo eight screws and then remove the side panels.

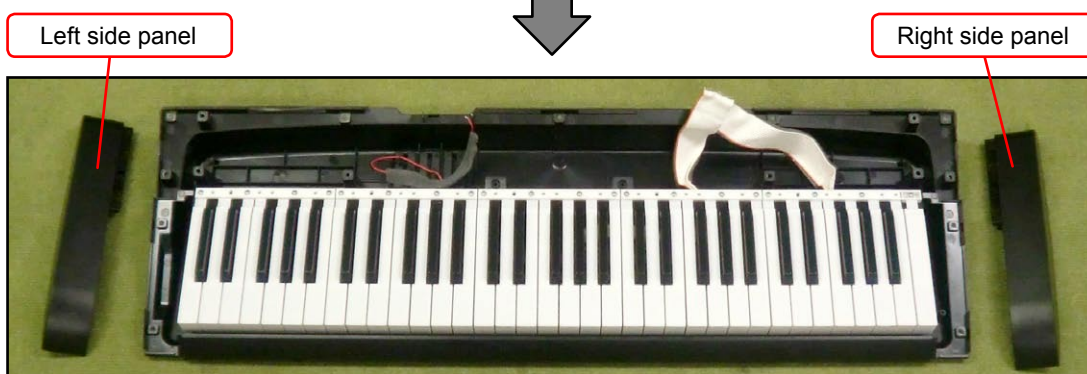
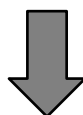
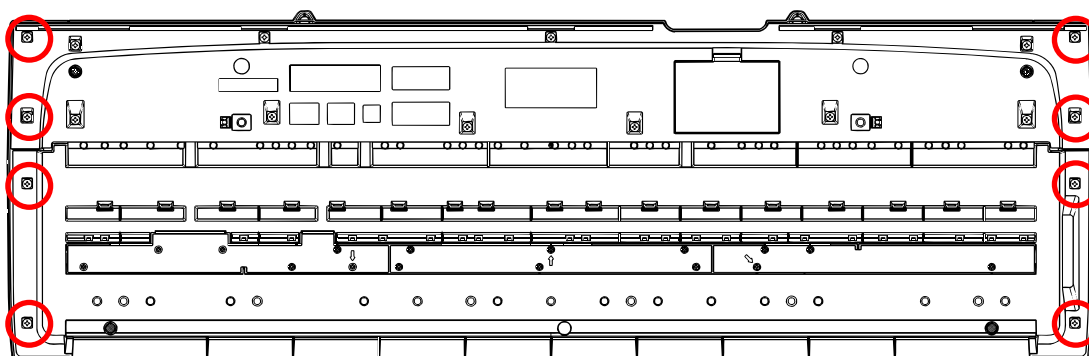

D-2. Undo 21 screws and then remove the white keys and black keys.

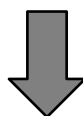
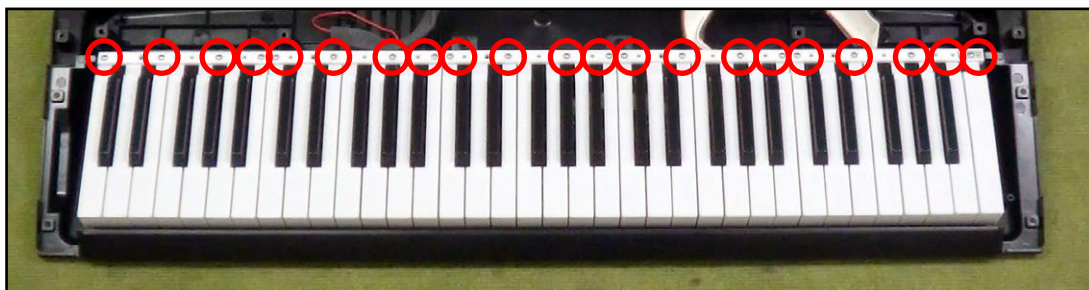

E. KEYBOARD PCB (M800-KYA1/KYA2)

E-1. Disengage the hooks and then remove the M800-KYA1/KYA2 PCBs.

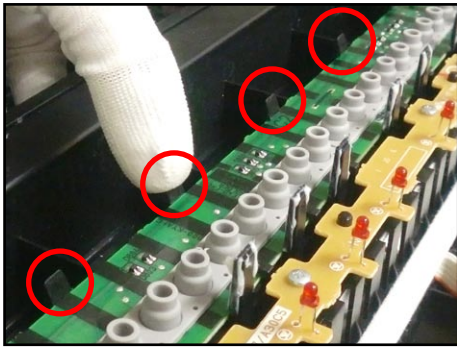

E-2. Remove five rubber contact strips.

NOTE: One rubber contact strip differs in length.

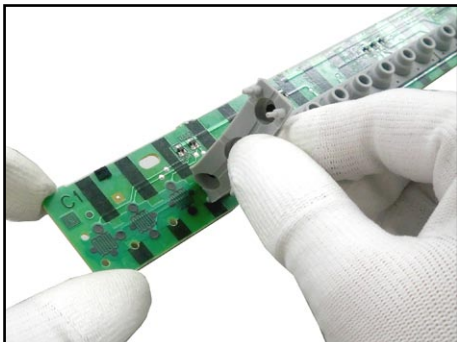
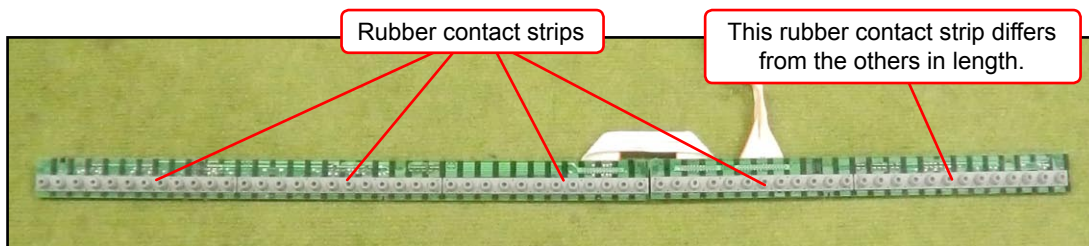

<How to install rubber contact strips>

Lightly insert the tip of a rubber contact strip into the PCB. Pull the tip from the back of the PCB and install it using a tool such as tweezers. Do not forcibly pull it.

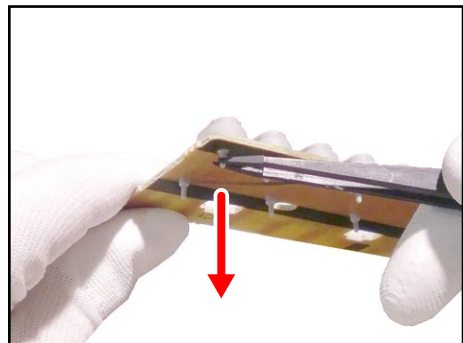

F. KEYBOARD LED PCB (M821-LDA1/LDA2, CSM446-LD3M/LD4M/LD5M)

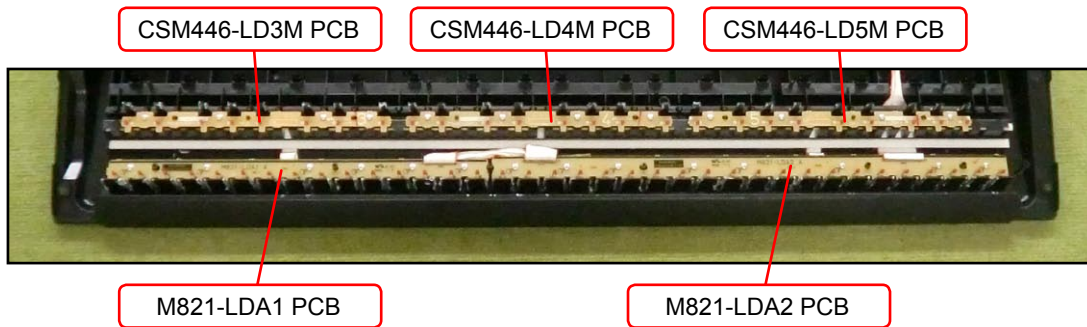

F-1. Undo 14 screws on the M821-LDA1/LDA2 PCBs.

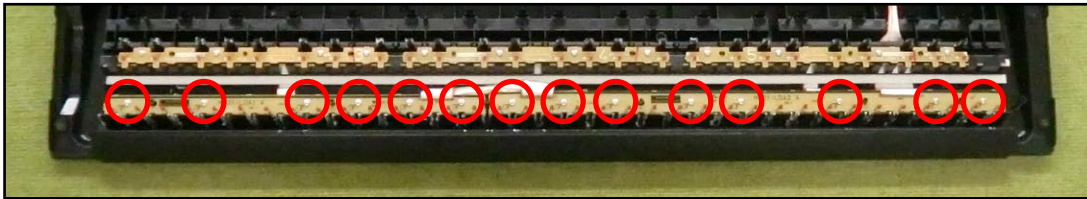

F-2. Turn over the M821-LDA1/LDA2 PCBs.

NOTE: Do not touch the LEDs.

F-3. Unsolder three FFCs and then remove the M821-LDA1/LDA2 PCBs.

NOTE: After repairing, arrange the FFCs again.

F-4. Undo 12 screws on the CSM446-LD3M/LD4M/LD5M PCBs and then remove the CSM446-LD3M/LD4M/LD5M PCBs.

NOTE: After repairing, arrange the FFCs again.

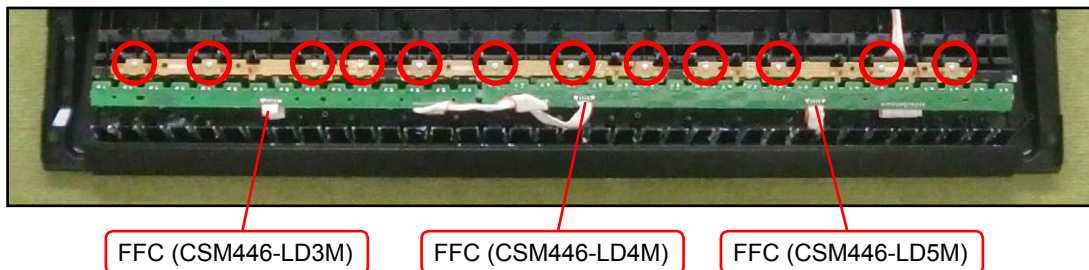

DIAGNOSTIC PROGRAM

■ INITIAL SETTING

- (1) Connect the AC adaptor.
- (2) Turn the volume to the maximum.

■ HOW TO START THE DIAGNOSTIC PROGRAM

- (1) Hold down the “0” and “START/STOP” buttons at the same time, to turn the power ON.

NOTE: Set the mode switch to the “NORMAL”.

NOTE: Be sure to turn off the power when the test is finished.

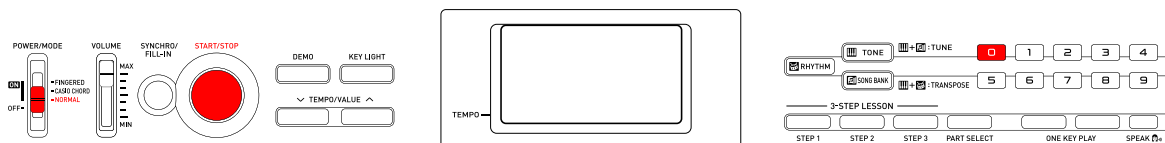

- (2) Release the “0” and “START/STOP” buttons.
- (3) After the diagnostic program is launched, the test menu appears.

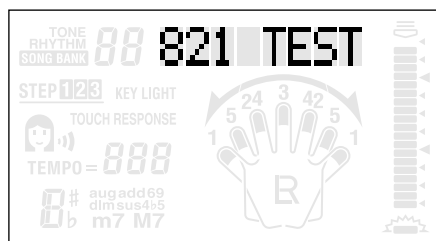

■ TEST ITEMS

Pushing a test button enables the corresponding test item to be tested.

Test Items	Buttons	Note
A. Mode Switch Check		
B. Button Check	0	
C. ROM Version Check	1	
D. Keyboard LED Check	TONE	
E. LCD Check	STEP 1	
F. Auto Power Off Check	PART SELECT	

This diagnostic program does not test the following items.

Check the functions with regular power-on state.

Test Items	Buttons	Note
G. Keyboard Check		
H. Headphones Check		Headphones

■ DIAGNOSTIC PROGRAM

A. MODE SWITCH CHECK

A-1. Switch the mode switch and check that the following screen appears on the LCD.

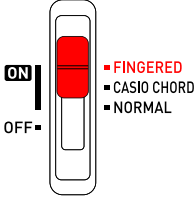
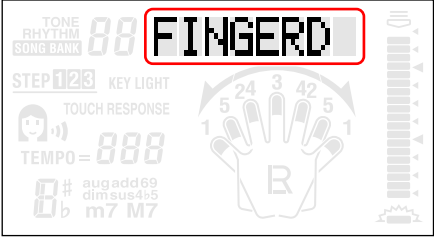
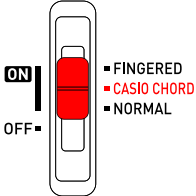
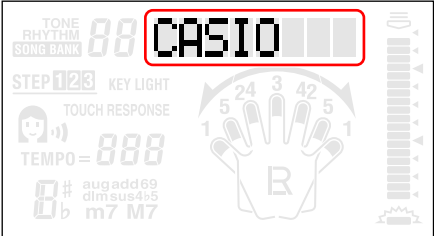
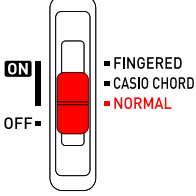
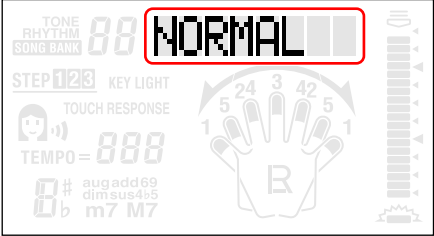
Mode Switch	LCD
<p>FINGERED POWER/MODE</p>  <p>ON</p> <p>OFF</p> <ul style="list-style-type: none"> ■ FINGERED ■ CASIO CHORD ■ NORMAL 	
<p>CASIO CHORD POWER/MODE</p>  <p>ON</p> <p>OFF</p> <ul style="list-style-type: none"> ■ FINGERED ■ CASIO CHORD ■ NORMAL 	
<p>NORMAL POWER/MODE</p>  <p>ON</p> <p>OFF</p> <ul style="list-style-type: none"> ■ FINGERED ■ CASIO CHORD ■ NORMAL 	

B. BUTTON CHECK

B-1. Press the “0” button to select the “Button Check”.

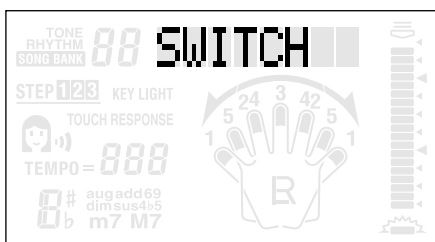

B-2. Press the keys in the order of the numbers indicated in the illustration below.

If the button function is OK:

The confirmation chord sounds, and the button number and “OK” appear on the LCD.

If a button function is not operating properly or a button is pressed in a wrong order:

The error tone sounds, and the button number and “NG” appear on the LCD.

NOTE: You cannot cancel this check procedure mid-way.

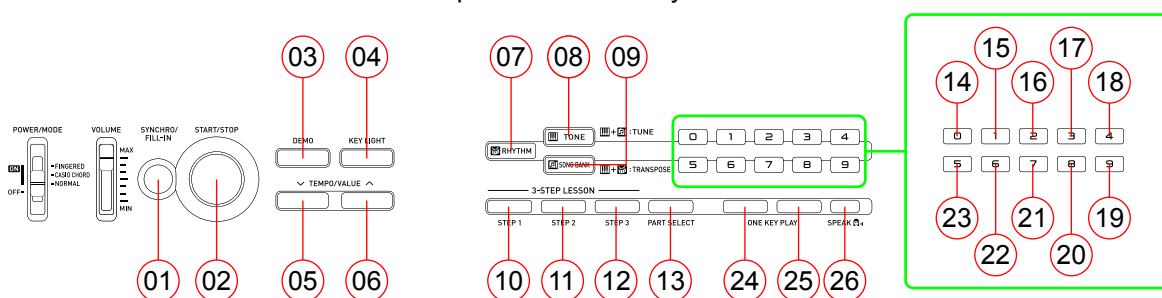

B-3. When the “SPEAK” button is pressed at the end, the confirmation chord sounds and “SWITCHOK” appears on the LCD.

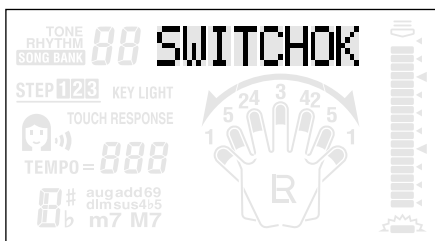

C. ROM VERSION CHECK

C-1. Press the “1” button to perform the “ROM Version Check”.

The ROM version appears on the LCD.

C-2. Check that the ROM version is “821VR100”.

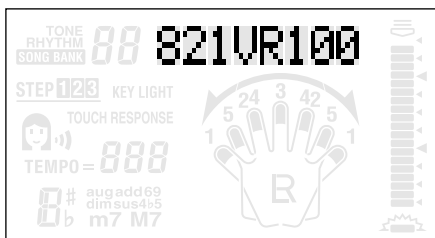

D. KEYBOARD LED CHECK

- D-1. Press the “TONE” button to perform the “LED Check”.
Automatically the keyboard LEDs are lit.

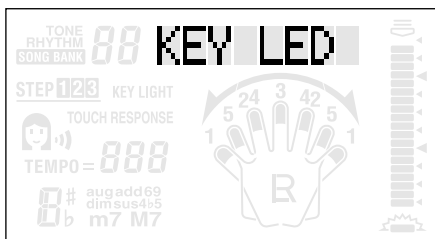

Check the following points.

- The confirmation chords sound and the LEDs are lit in the order indicated in the illustration below.
- There should be no key of which LED brightness is too bright or too faint.

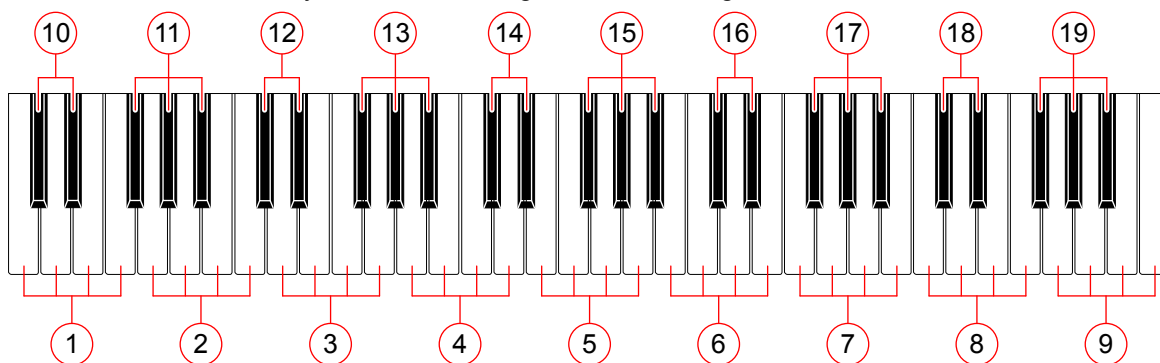

E. LCD CHECK

- E-1. Press the “STEP 1” button to perform the “LCD Check”.
The confirmation chord sounds and the display of the LCD is lit.

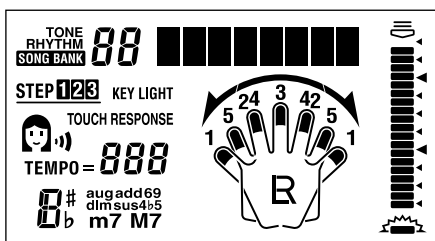

- E-2. Press the “STEP 2” button.
The confirmation chord sounds and the display of the LCD is turned off.

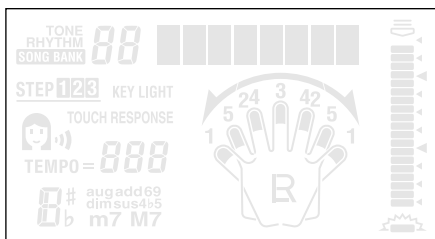

E-3. Press the “STEP 3” button.

The LCD displays automatically change with the confirmation chords in the order indicated in the illustration below.

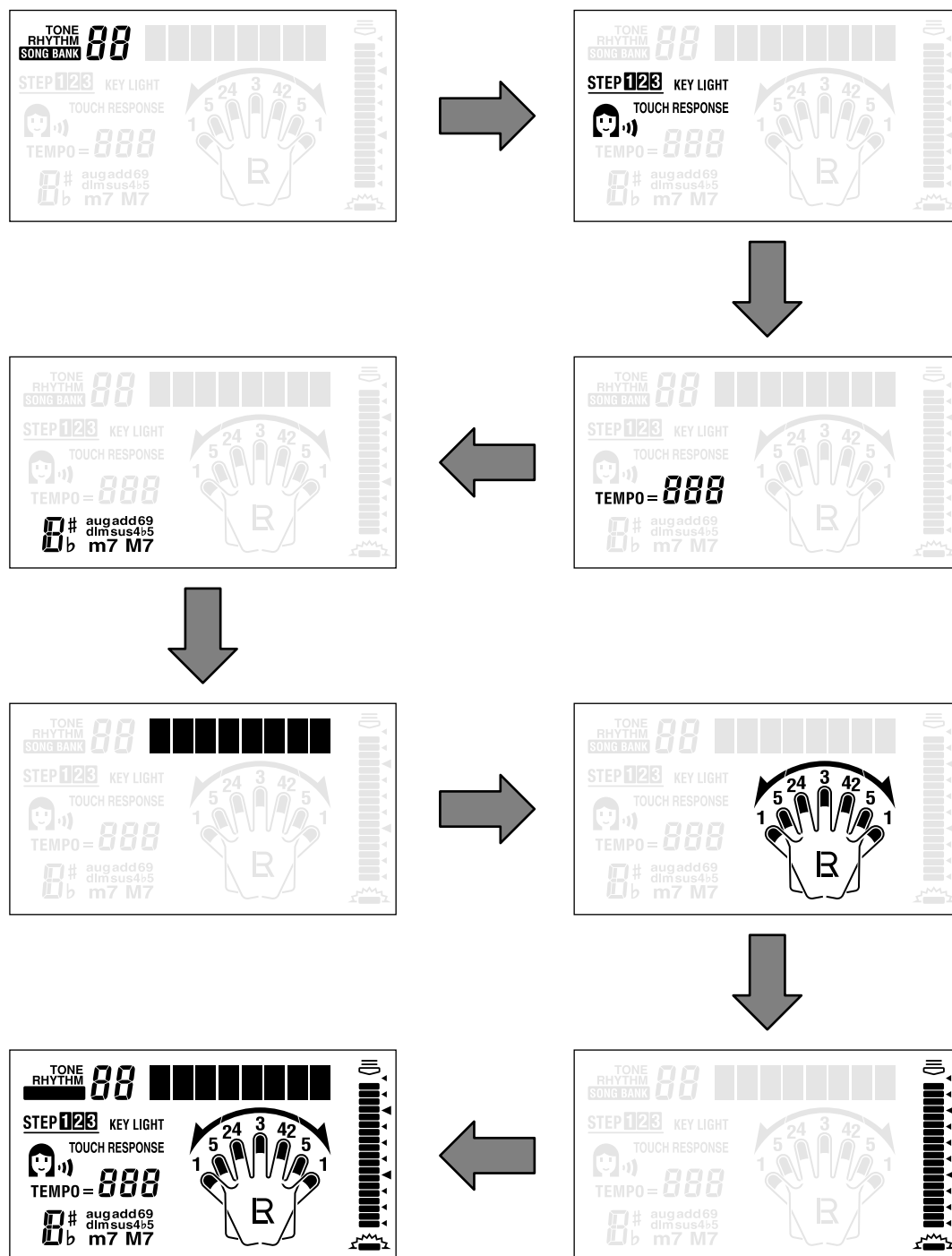

F. AUTO POWER OFF CHECK

F-1. Press the “PART SELECT” button to perform the “Auto Power Off Check”.

F-2. The power supply is turned off and no screen appears on the LCD.

NOTE: After checking, be sure to turn the mode switch to “OFF”.

G. KEY CHECK

NOTE: Perform the tests with regular power-on state.

G-1. Check the following points by pressing all keys.

- The tones sound correctly by hitting keys.
- The pitch of the sound corresponding to a key is correct.
- Hitting a key does not produce two tones or make sounds twice.
- The stroke and the load of keys are normal.
- The difference in height and the gap between keys are even.

NOTE: Press the keys in the order shown in the illustration below.

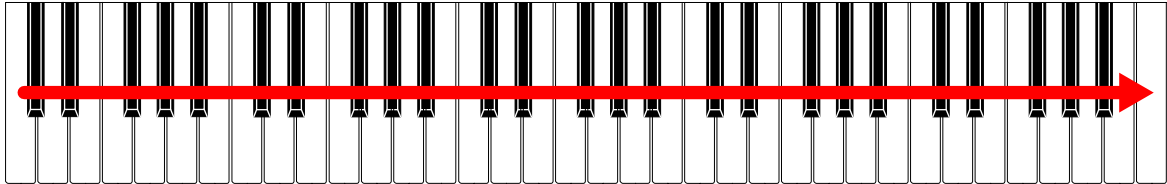

H. HEADPHONES CHECK

NOTE: Perform the tests with regular power-on state.

- H-1. Connect the headphones to the PHONES/OUTPUT jack.
- H-2. Press any key and check that you can hear the sound through the headphones.
- H-3. Remove the headphones.
- H-4. Press any key and check that sounds come out from the speakers.

EXPLODED VIEW

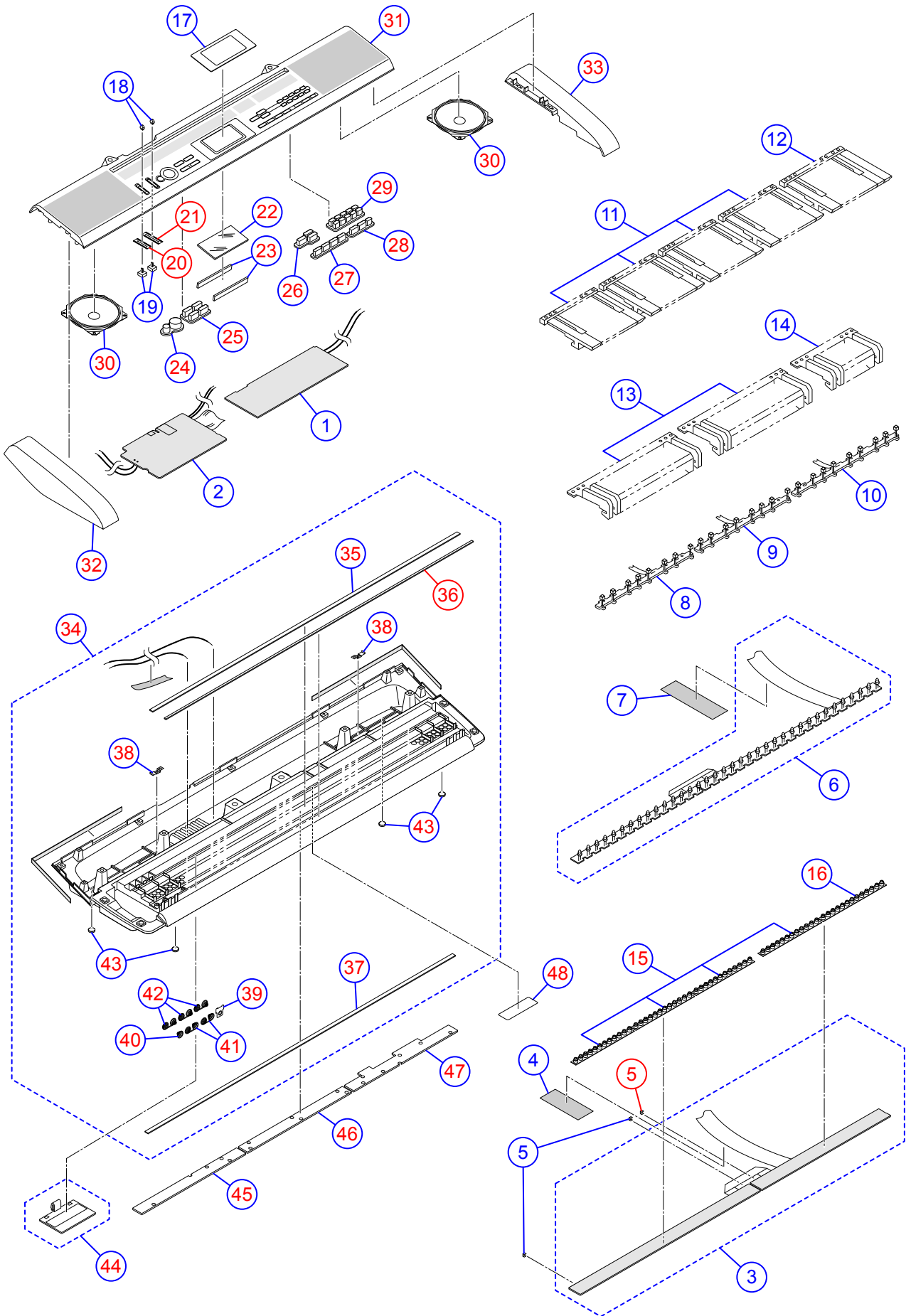

PARTS LIST

LK-125

Notes:

1. Prices and specifications are subject to change without prior notice.
2. Refer to the latest "Parts Price Code" at "PARTS FINDER" on the Casio Service WEB site (<https://www.servicecasio.com>).
3. As for spare parts order and supply, refer to the "GUIDEBOOK for Spare parts Supply", published separately.
4. The numbers in item column correspond to the same numbers in drawing.

- 1: LK-125_DI
- 2: LK-125_EU
- 3: LK-125_UK
- 4: LK-125_US

N	Item	Code No.	Parts Name	Specification	Q'ty				Price Code	R	Remarks
					1	2	3	4			
MAIN PCB											
	1	10368210	PCB ASSY/MDA1	TK-RJM510419*001	1	1	1	1		B	MDA1 PCB
	CN8	10178633	WIRE/for speaker	1007TASC24100B4040	1	1	1	1		X	Blue (+)
	CN9	10366747	WIRE/for speaker	1007TASC24100W4040	1	1	1	1		X	White (-)
	VR1	69304870	VARIABLE RESISTOR	EVND8AA03B53	1	1	1	1		X	LCD Contrast Volume
	D1-D8	10276977	DIODE	L1SS400T1G	8	8	8	8		X	
	IC4	10240586	IC	XC6109N40ANR	1	1	1	1		X	
	IC1	10363062	LSI	ML6756B32GAZ03A114	1	1	1	1		C	
	IC3	10222381	LSI	ST7066U-0A-QG	1	1	1	1		C	
	IC2	10159709	LSI	UPD65881GK-1019ETA	1	1	1	1		C	
	Q9	69300298	TRANSISTOR	2SC4081T106R	1	1	1	1		X	
	Q5-Q8	10209018	TRANSISTOR	KTA501U-GR-RTK/P	4	4	4	4		X	
	Q1-Q4	10207076	TRANSISTOR	KTC601U-GR-RTK/P	4	4	4	4		X	
	TH1	10138692	THERMISTOR	NCP18XH103J03RB	1	1	1	1		X	
	X1	10070555	RESONATOR	CSTCW20M0X51-R0	1	1	1	1		X	
POWER AMP PCB											
	2	10368211	PCB ASSY/PSA1	TK-RJM510421*001	1	1	1	1		C	PSA1 PCB
	CN205,CN206	10178633	WIRE/for speaker	1007TASC24100B4040	2	2	2	2		X	Blue (+)
	CN204,CN207	10366747	WIRE/for speaker	1007TASC24100W4040	2	2	2	2		X	White (-)
	J201	35015103	JACK	HEC3110-01-010	1	1	1	1		B	DCJack
	J202	10305218	JACK	JY-6316B*01-070	1	1	1	1		C	Phones/Output Jack
	IC201	10300598	IC	TA8227APL-D12-H-T	1	1	1	1		X	
	L202	10231919	COIL	RB53-856396NP	1	1	1	1		X	
	L201	10231920	COIL	RB53-856397NP	1	1	1	1		X	
	D203-D204	10261170	DIODE	SRT14-A2	2	2	2	2		X	
	D206-D207	79114195	DIODE	UDZSTE-175.6B	2	2	2	2		X	
	D201-D202	10371167	DIODE	L1SS355T1G	2	2	2	2		X	
	Q204	10206676	TRANSISTOR	KTC2026-Y-U/P	1	1	1	1		X	
	Q201	69300298	TRANSISTOR	2SC4081T106R	1	1	1	1		X	
	Q202	10217742	TRANSISTOR	KTA1270-Y-AT/P	1	1	1	1		X	
	Q203	10209015	TRANSISTOR	KTD863-GR-AT/P	1	1	1	1		X	
KEYBOARD PCB											
	3	10368208	PCB ASSY/KYA	TK-RJM508609*002	1	1	1	1		C	KYA PCBs
	D801-D830,D832	10301580	DIODE	LM1MA142WAT1G	31	31	31	31		X	
	4	10078918	SPONGE/40X100	M440962-001V01	1	1	1	1		X	
	5	69268840	FABRIC TAPE/4X10	M440684-1	3	3	3	3		X	
	6	10368212	PCB ASSY/LDA	TK-RJM510423*001	1	1	1	1		C	LDA PCBs
	D501-D536	10302396	LED	1154SURDKB5/7.5-90	36	36	36	36		X	
	7	10263729	SPONGE/43X180	M441123-001V01	1	1	1	1		X	
	8	10310713	PCB ASSY/LD3M	TK-M240428*011	1	1	1	1		C	LD3M PCB
	LED451-LED458	10302396	LED	1154SURDKB5/7.5-90	8	8	8	8		X	
	9	10310714	PCB ASSY/LD4M	TK-M240429*011	1	1	1	1		C	LD4M PCB
	LED459-LED466	10302396	LED	1154SURDKB5/7.5-90	8	8	8	8		X	
	10	10310715	PCB ASSY/LD5M	TK-M240430*011	1	1	1	1		C	LD5M PCB
	LED467-LED475	10302396	LED	1154SURDKB5/7.5-90	9	9	9	9		X	
KEYBOARD UNIT											
	11	10304700	WHITE KEY/CB	TK-RJM507243*003	4	4	4	4		C	
	12	10304699	WHITE KEY/CS	TK-RJM507244*003	1	1	1	1		C	
	13	10301442	BLACK KEY/10P	RJM506595-009V02	2	2	2	2		C	
	14	10301443	BLACK KEY/5P	RJM506595-010V02	1	1	1	1		C	
	15	10163902	RUBBER CONTACT/CB	RJM503854-001V01	4	4	4	4		B	
	16	10163903	RUBBER CONTACT/CS	RJM503855-001V01	1	1	1	1		B	

- 1: LK-125_DI
- 2: LK-125_EU
- 3: LK-125_UK
- 4: LK-125_US

N	Item	Code No.	Parts Name	Specification	Q'ty				Price Code	R	Remarks
					1	2	3	4			
PANEL UNIT											
	17	10371166	PLATE/DISPLAY	RJM510316-003V02	1	1	1	1		X	
	18	10301435	KNOB	RJM503803-009V01	2	2	2	2		X	
	19	69095890	CONTACT/SLIDE SWITCH	CSB-12D	2	2	2	2		X	
N	20	10417026	FABRIC TAPE	RJM511849-001V01	1	1	1	1		X	
N	21	10417025	FABRIC TAPE	RJM511833-001V01	1	1	1	1		X	
	22	10272509	LCD	SDT-M4396-RP-0	1	1	1	1		X	
	23	10366853	RUBBER CONNECTOR	RJM510317-001V01	2	2	2	2		X	
	24	10366689	RUBBER KEY/A	RJM510262-002V01	1	1	1	1		X	
	25	10366690	RUBBER KEY/B	RJM510264-002V01	1	1	1	1		X	
	26	10366692	RUBBER KEY/C	RJM510282-002V01	1	1	1	1		X	
	27	10366693	RUBBER KEY/D	RJM510283-002V01	1	1	1	1		X	
	28	10366694	RUBBER KEY/E	RJM510284-002V01	1	1	1	1		X	
	29	10366695	RUBBER KEY/F	RJM510285-001V01	1	1	1	1		X	
	30	10264808	SPEAKER	C10J01A	2	2	2	2		X	
N	31	10377336	PANEL	RJM510265-005V01	1	1	1	1		X	
	32	10366841	SIDE PANEL/LEFT	RJM510267-001V01	1	1	1	1		X	
	33	10366842	SIDE PANEL/RIGHT	RJM510268-001V01	1	1	1	1		X	
MAIN CASE UNIT											
	34	10368209	CASE UNIT/MAIN	TK-RJM510380*001	1	1	1	1		X	
	35	10301471	FELT/LOWER	RJM508593-001V01	1	1	1	1		X	
	36	10317116	FELT/DAMPER/KEYBOARD	RJM509138-001V01	1	1	1	1		X	
	37	10205015	FELT/UPPER	M440342-001V02	1	1	1	1		X	
	38	10284332	BRACKET/for stand	M440866-001V02	2	2	2	2		X	
	39	69271080	BATTERY SPRING/(+)	M440112-1	1	1	1	1		X	
	40	10274835	BATTERY SPRING/(-)	M440002-001V02	1	1	1	1		X	
	41	69271060	BATTERY SPRING-470A	M440676-1	2	2	2	2		X	
	42	69271070	BATTERY SPRING-470B	M440677-1	3	3	3	3		X	
	43	69226920	RUBBER FOOT	M41361-6	4	4	4	4		X	
	44	10243428	COVER ASSY/BATTERY	TK-M340884*020	1	1	1	1		X	
	45	10329837	LOWER COVER-A	RJM508655-001V03	1	1	1	1		X	
	46	10329838	LOWER COVER-B	RJM508656-001V03	1	1	1	1		X	
	47	10329839	LOWER COVER-C	RJM508657-001V03	1	1	1	1		X	
N	48	10377332	RATING LABEL	RJM504373-042V02	1	1	1	1		X	
ACCESSORIES											
	-	10366857	MUSIC STAND	RJM510426-001V01	1	1	1	1		C	

SCHEMATIC DIAGRAMS

Main PCB: M821-MDA1

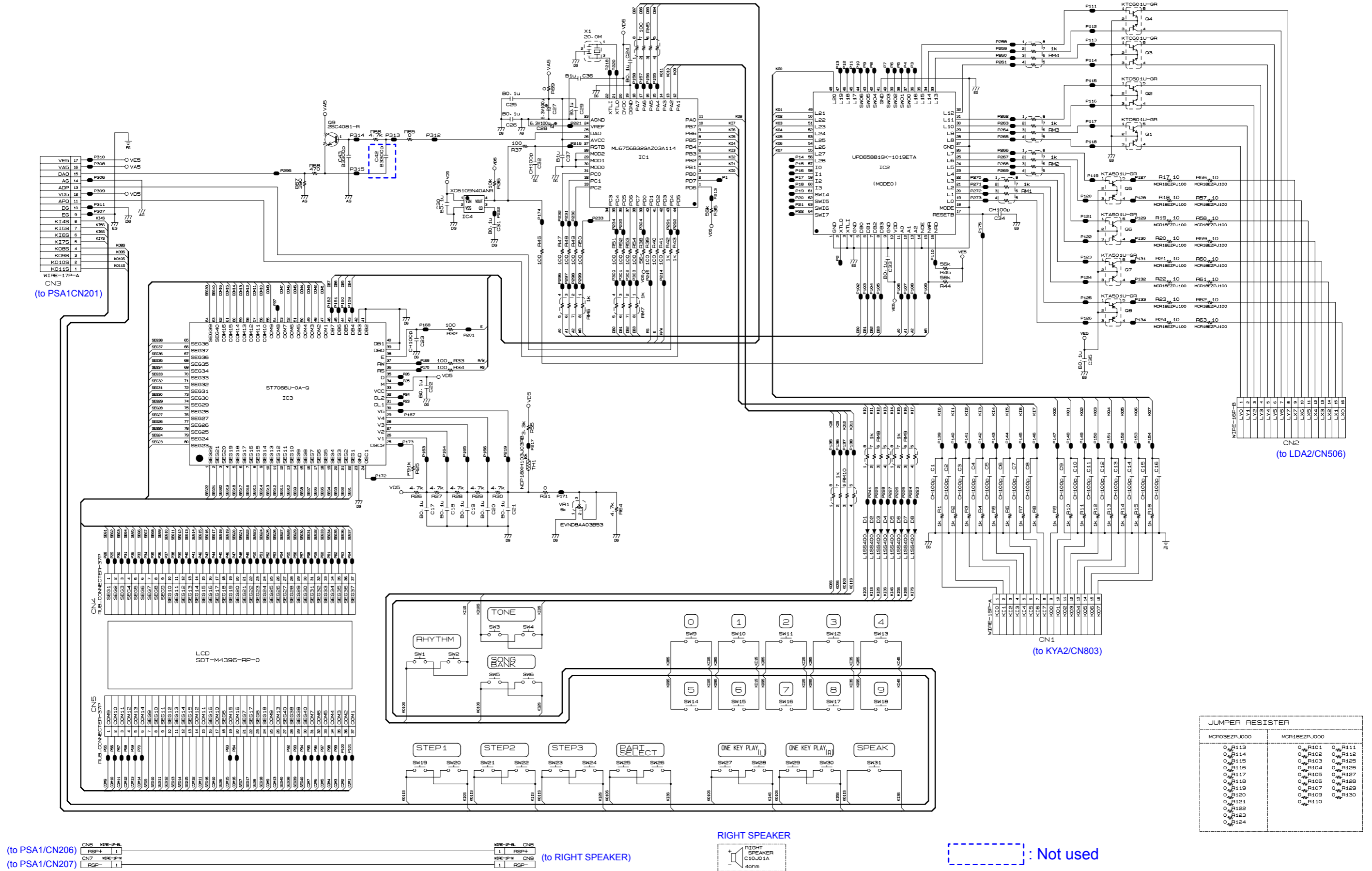

JUMPER RESISTER	
MCR03E2P-000	MCR18E2P-000
○ _W R113	○ _W R101
○ _W R114	○ _W R102
○ _W R115	○ _W R103
○ _W R116	○ _W R104
○ _W R117	○ _W R105
○ _W R118	○ _W R106
○ _W R119	○ _W R107
○ _W R120	○ _W R108
○ _W R121	○ _W R109
○ _W R122	○ _W R110
○ _W R123	
○ _W R124	

(to PSA1/CN206)
 (to PSA1/CN207)

(to RIGHT SPEAKER)



: Not used

Power Amp PCB: M820-PSA1

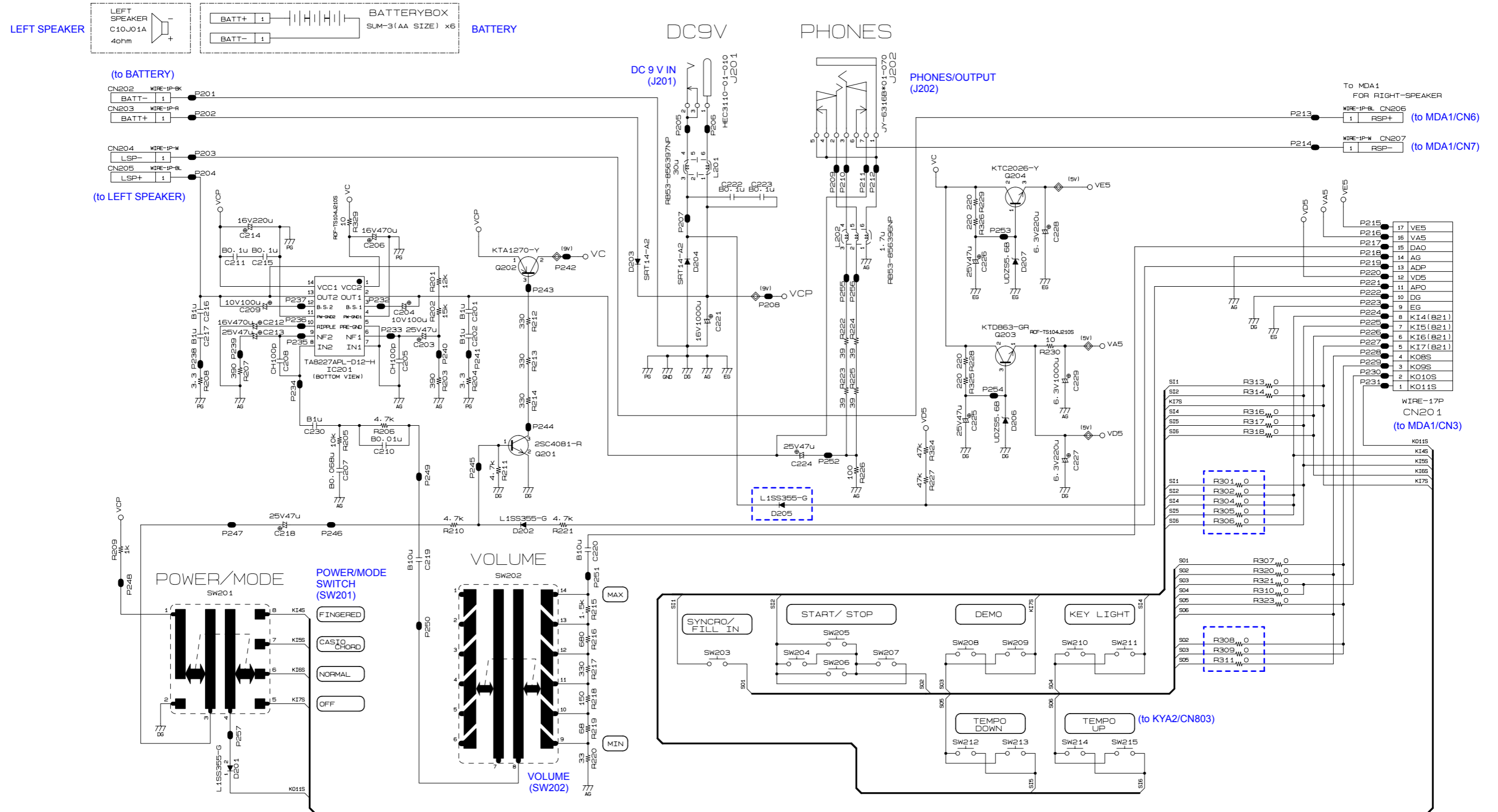

JUMPER RESISTOR

0 _W R401	0 _W R411	0 _W R421	0 _W R431	0 _W R441
0 _W R402	0 _W R412	0 _W R422	0 _W R432	0 _W R442
0 _W R403	0 _W R413	0 _W R423	0 _W R433	0 _W R443
0 _W R406	0 _W R415	0 _W R424	0 _W R434	0 _W R445
0 _W R408	0 _W R416	0 _W R425	0 _W R440	0 _W R447
0 _W R409	0 _W R417	0 _W R426		0 _W R448
0 _W R410	0 _W R418	0 _W R427		0 _W R449
	0 _W R419	0 _W R428		0 _W R450
	0 _W R420	0 _W R429		0 _W R451

 : Not used

Keyboard LED PCB: M821-LDA1

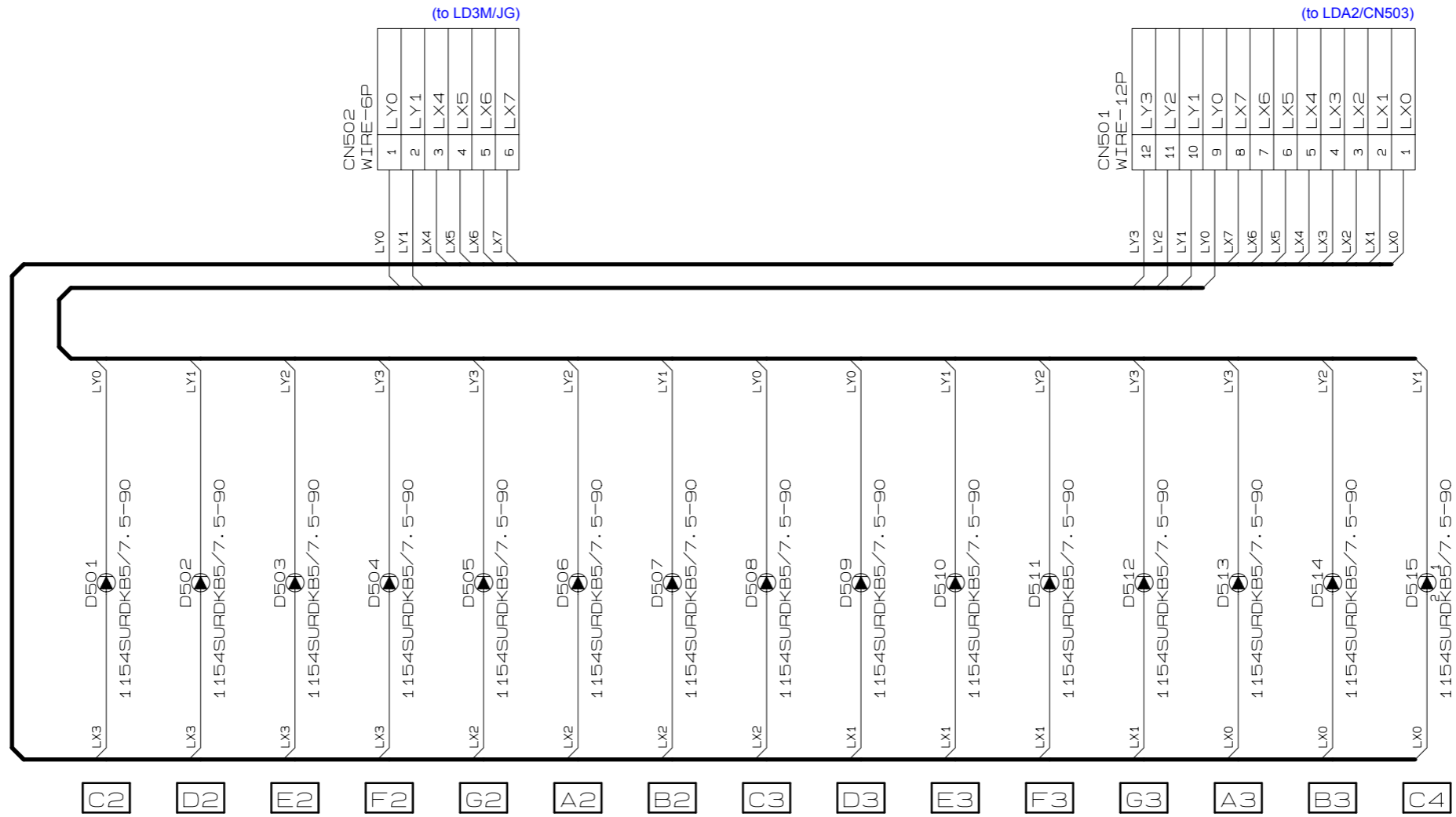

Keyboard LED PCB: M821-LDA2

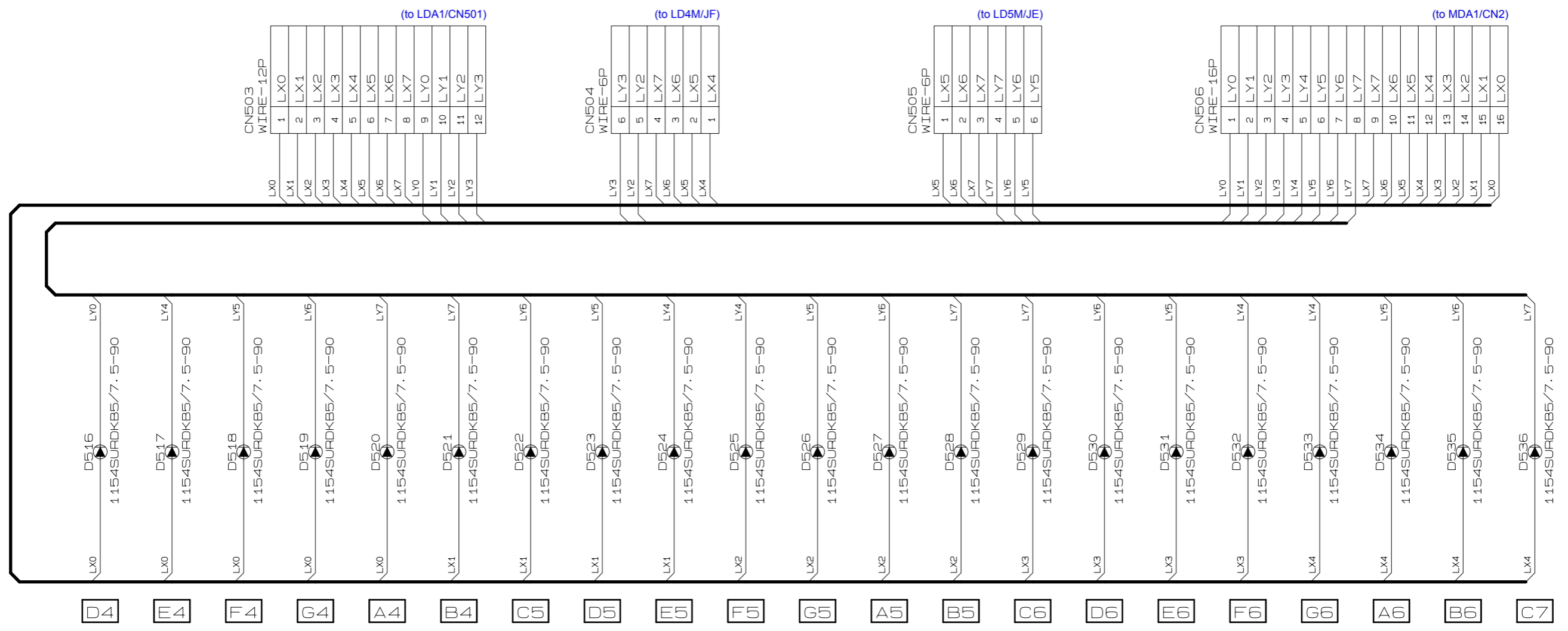

Keyboard LED PCB: CSM446-LD3M/LD4M/LD5M

CSM446-LD3M

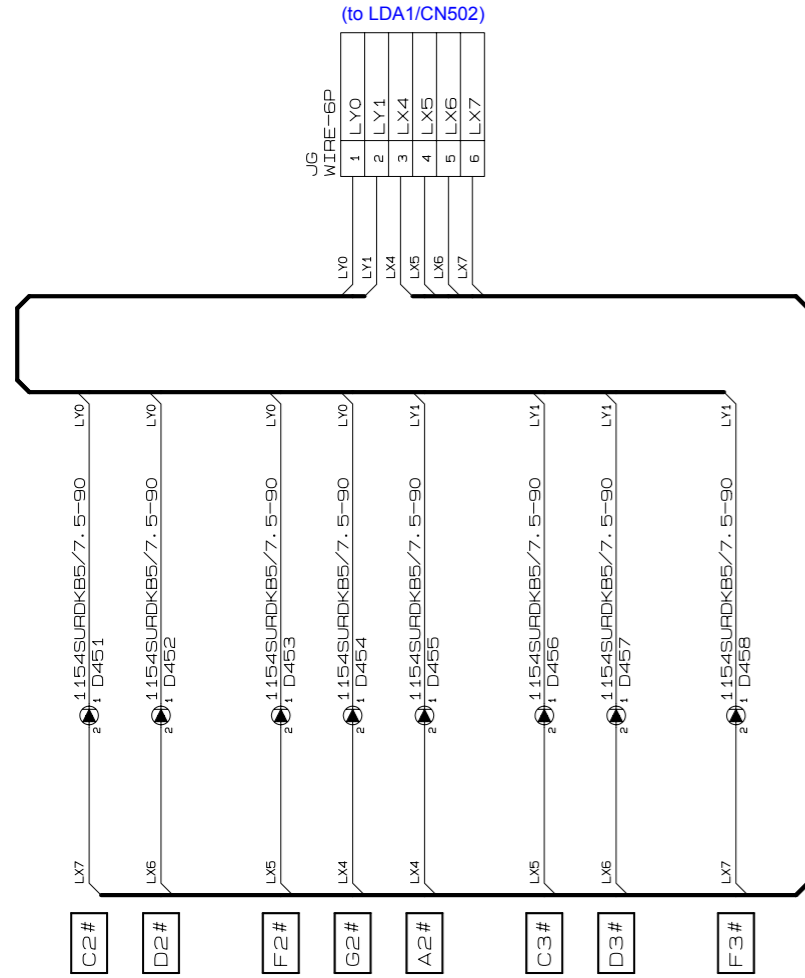

CSM446-LD4M

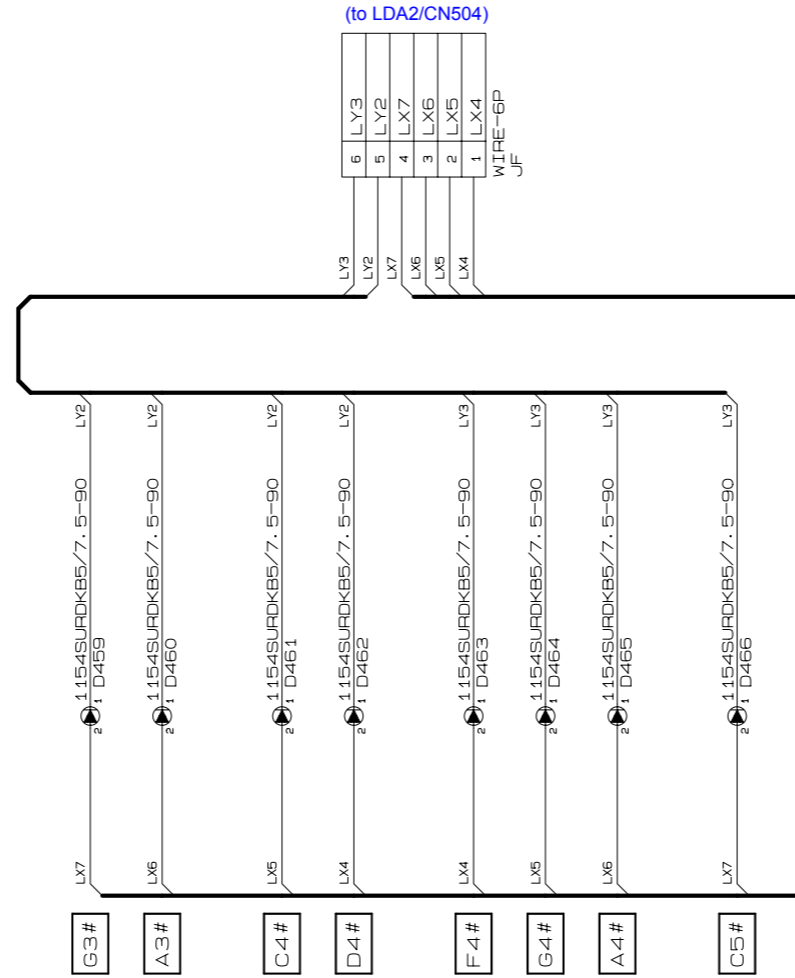

CSM446-LD5M

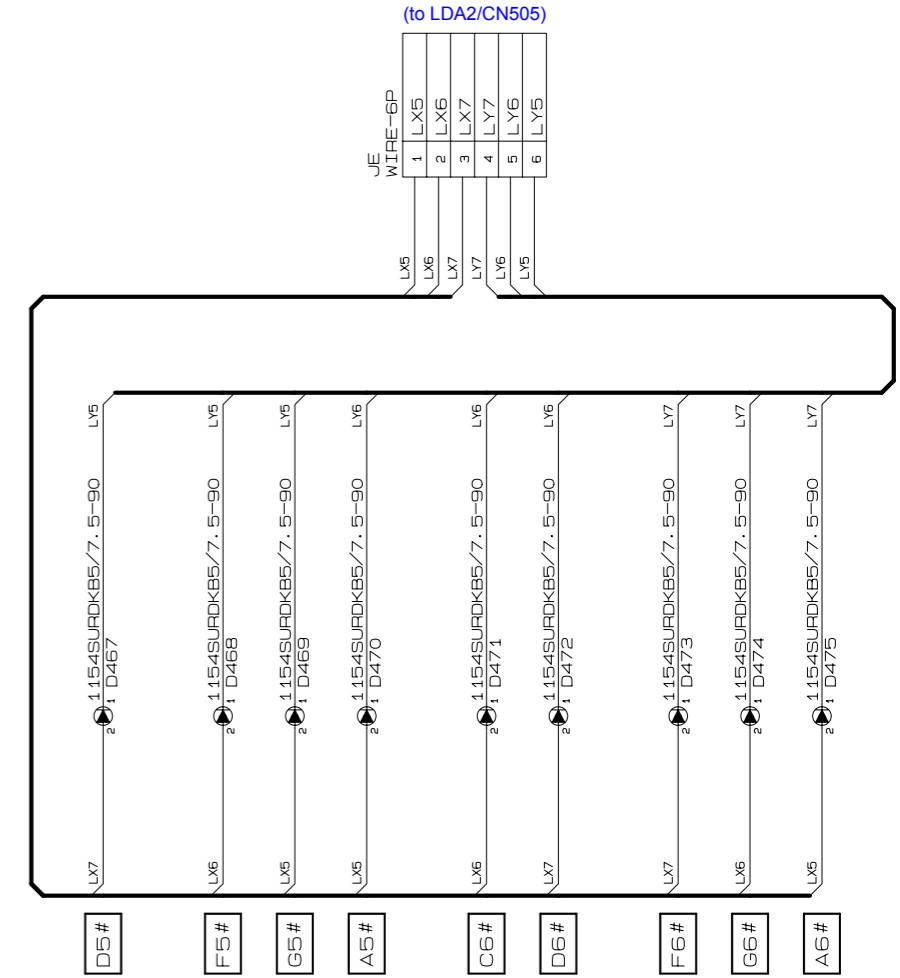

Keyboard PCB: M800-KYA1/KYA2

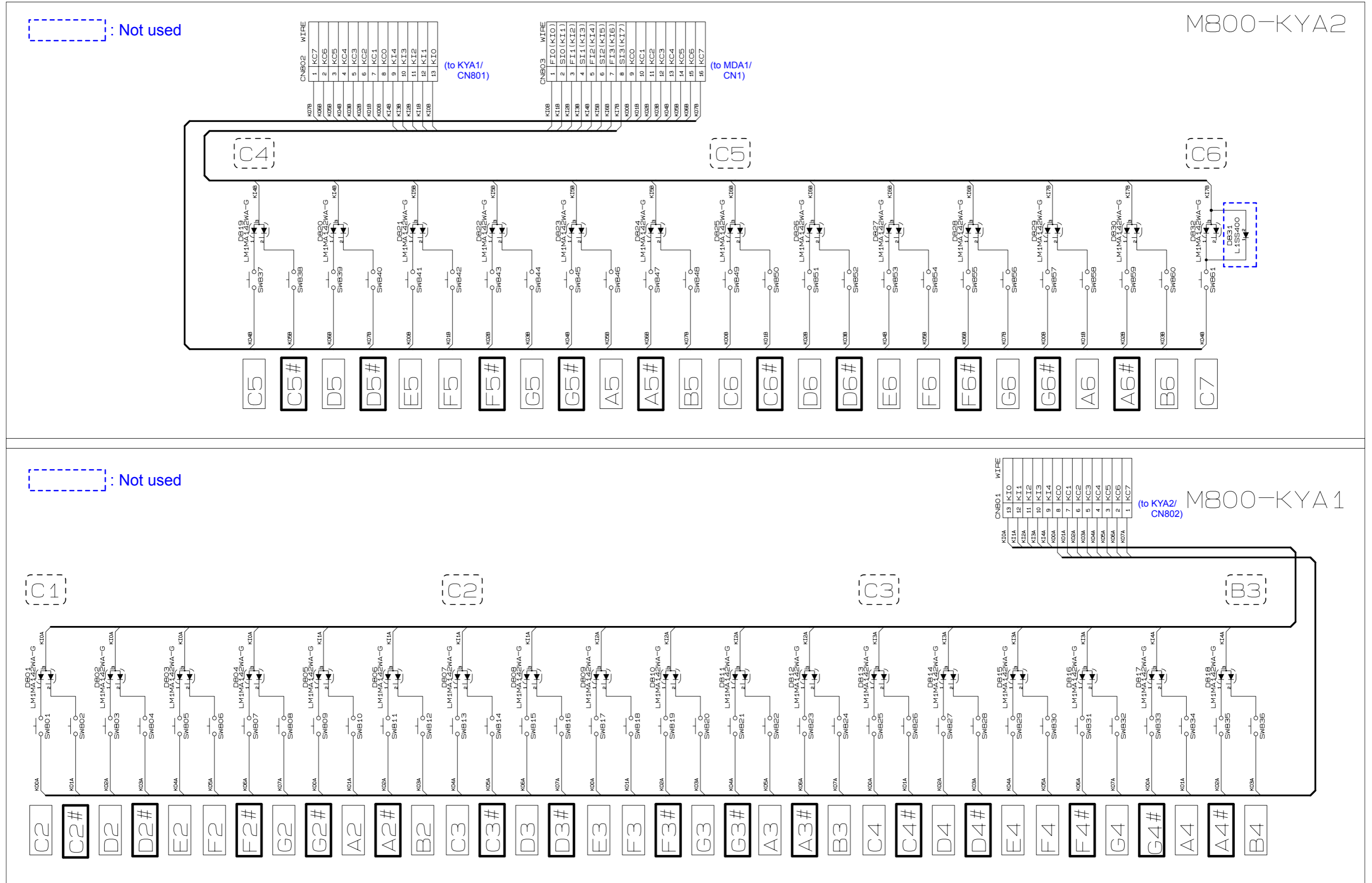

Ver. 1 : Dec. 2011

- Correction of the PARTS LIST (P24)

Ver. 2 : Jan. 2012

- Correction of the EXPLODED VIEW (P22)
- Correction of the PARTS LIST (P24 and P25)

CASIO COMPUTER CO.,LTD.

Overseas Service Division

6-2, Hon-machi 1-Chome
Shibuya-ku, Tokyo 151-8543, Japan