

SERVICE MANUAL & PARTS LIST

LK-127

MAR. 2013

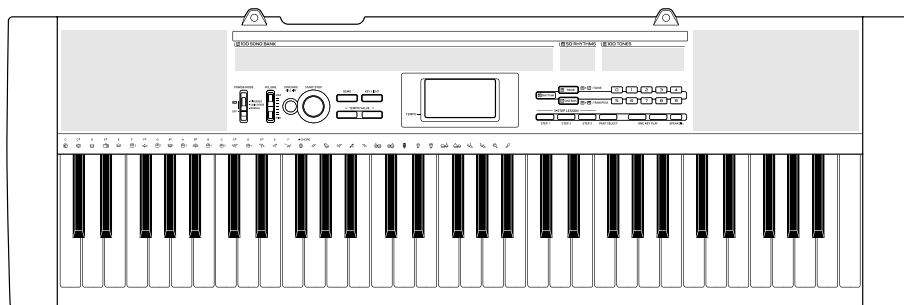

CASIO®

CONTENTS

SPECIFICATIONS.....	1
BLOCK AND WIRING DIAGRAM	2
PCB INFORMATION	3
CIRCUIT DESCRIPTION	4
PRINTED CIRCUIT BOARDS.....	5
DISASSEMBLY	7
DIAGNOSTIC PROGRAM	16
EXPLODED VIEW.....	22
PARTS LIST	23
SCHEMATIC DIAGRAMS.....	27

SPECIFICATIONS

Keyboard	61 standard-size keys; 5 octaves
Key Light System	Can be turned on and off (up to 4 keys can be lit at the same time)
Tones	100 presets
Polyphony	12 notes maximum
3-Step Lesson System	Number of simultaneously lit keys; 4 3-Steps
Playback	1 tune repeat playback
Voice Fingering Guide	On/Off
Auto-accompaniment	
Rhythm Patterns	50 presets
Tempo	Adjustable, (216 steps, ♩ = 40 to 255), initial value; 120
Chords	Two systems; CASIO CHORD, FINGERED
Other	Fill-in pattern, Synchro start
Song Bank Tunes	100 tunes
Musical Information Function	Tone, Auto Accompaniment, Song Bank numbers and names; tempo, 3 step lesson display, chord name, fingering, timing indicator, key lighting, voice fingering
Other Functions	
Transpose	F# to C to F: half-note
Tuning	Adjustable A4 = Approx. 440 Hz ± 50 cents, Initial value: A4 = Approx. 440 Hz
Speakers	10 cm diameter × 2 (Output: 2 W + 2 W)
I/O Terminals	
Power Supply	DC 9.5 V jack
Headphones/Output	Stereo standard jack (Output is monaural.) [Output impedance 78 Ω, output voltage: 4 V (RMS) MAX]
Power Supply	2-way
Batteries	6 AA-size zinc-carbon batteries or alkaline batteries Battery Life: Approximately 4 hours continuous operation on alkaline batteries Approximately 1 hour continuous operation on zinc-carbon batteries
AC Adaptor	AD-E95100L
Auto Power Off	Approximately 6 minutes after the last operation
Power Consumption	9.5 V --- 7.7 W
Dimensions	94.9 × 30.4 × 9.3 cm (37 ³ / ₈ × 11 ¹⁵ / ₁₆ × 3 ¹¹ / ₁₆ inch)
Weight	Approximately 3.4 kg (7.5 lbs) (without batteries)

BLOCK AND WIRING DIAGRAM

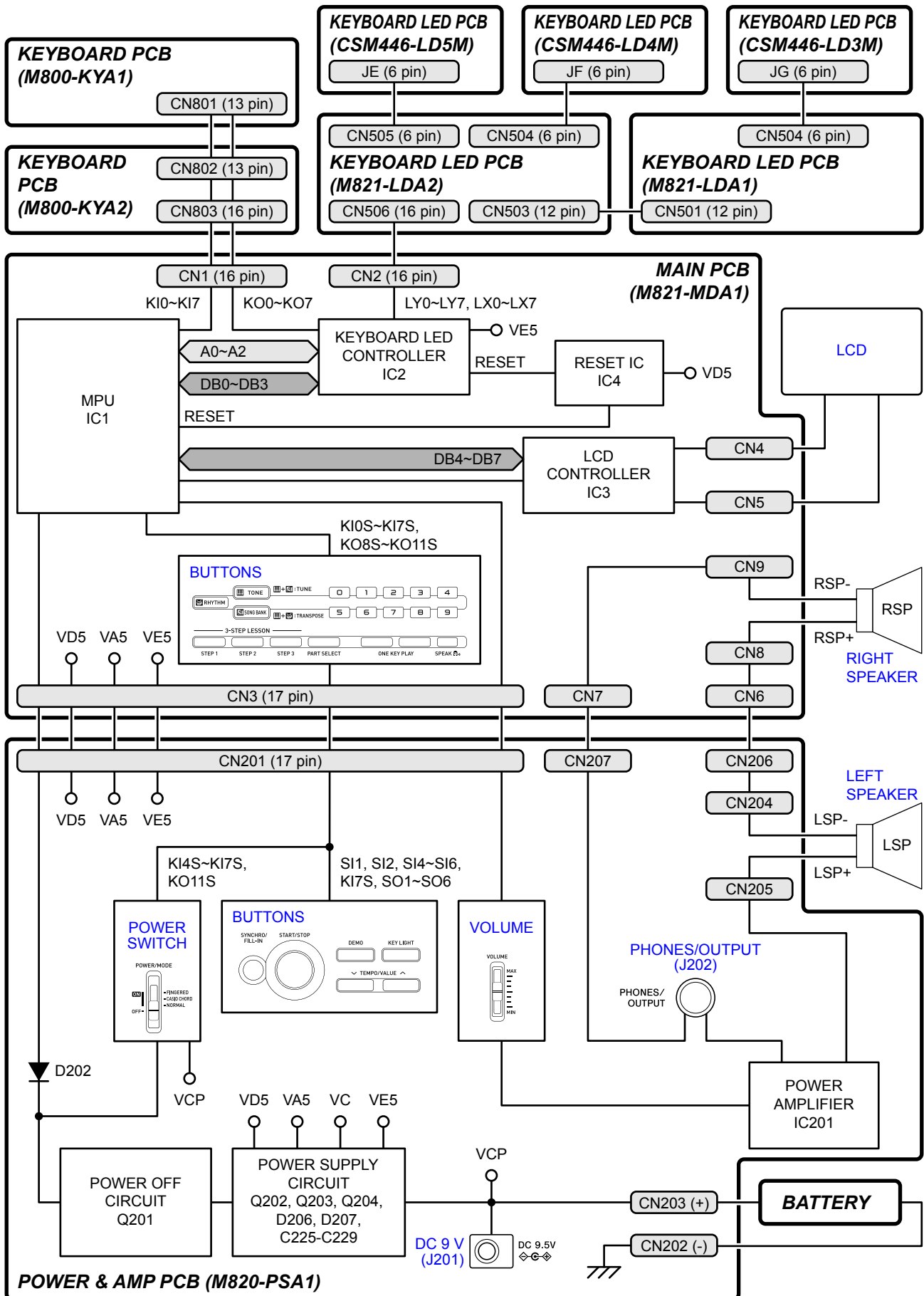

PCB INFORMATION

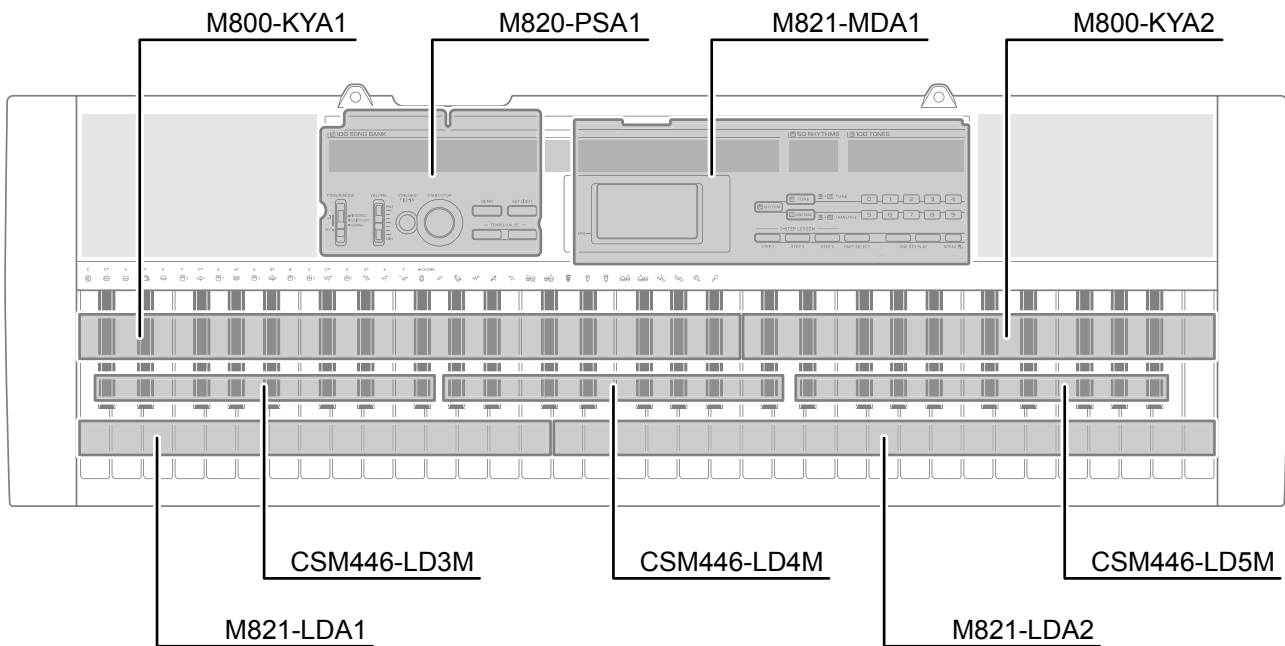

Parts Name	PCB Name	Functions
MAIN PCB		
PCB UNIT/MAIN	M821-MDA1	MPU, LCD controller, Keyboard LED controller, Reset IC, Buttons, Right speaker
POWER & AMP PCB		
PCB UNIT/ POWER & AMP	MX820-PSA1	Power supply circuit, Power amplifier, Power switch, Volume, Buttons, DC 9.5 V jack, Left speaker, PHONES/OUTPUT jack
KEYBOARD PCB		
PCB UNIT/KYA	M800-KYA1	Keyboard
	M800-KYA2	
KEYBOARD LED PCB		
PCB UNIT/LDA	M821-LDA1	Keyboard LED
	M821-LDA2	
PCB UNIT/LD3	CSM446-LD3M	
PCB UNIT/LD4	CSM446-LD4M	
PCB UNIT/LD5	CSM446-LD5M	

CIRCUIT DESCRIPTION

■ Nomenclature of Keys

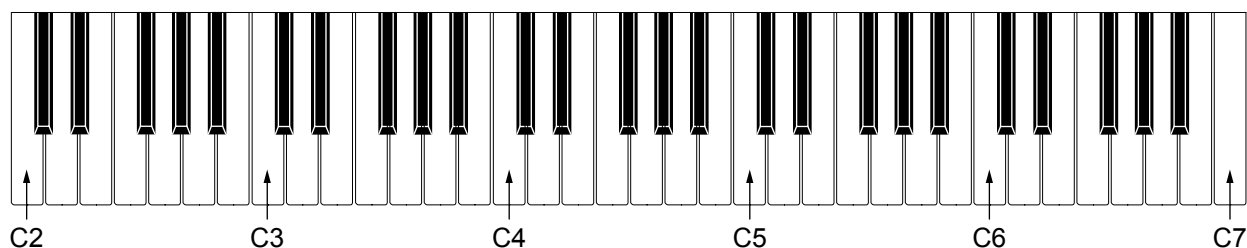

■ Key Matrix

	KC0	KC1	KC2	KC3	KC4	KC5	KC6	KC7
KI0	C2	C2#	D2	D2#	E2	F2	F2#	G2
KI1	G2#	A2	A2#	B2	C3	C3#	D3	D3#
KI2	E3	F3	F3#	G3	G3#	A3	A3#	B3
KI3	C4	C4#	D4	D4#	E4	F4	F4#	G4
KI4	G4#	A4	A4#	B4	C5	C5#	D5	D5#
KI5	E5	F5	F5#	G5	G5#	A5	A5#	B5
KI6	C6	C6#	D6	D6#	E6	F6	F6#	G6
KI7	G6#	A6	A6#	B6	C7			

■ Button Matrix

	KO8S	KO9S	KO10S	KO11S
KI0S	0	5	TONE	STEP 1
KI1S	1	6	RHYTHM	STEP 2
KI2S	2	7	SONG BANK	STEP 3
KI3S	3	8	PART SELECT	SPEAK
KI4S	4	9	ONE KEY PLAY LEFT	FINGERED (POWER/MODE)
KI5S	START/STOP	TEMPO DOWN/ VALUE	ONE KEY PLAY RIGHT	CASIO CHORD (POWER/MODE)
KI6S	TEMPO UP/ VALUE		KEY LIGHT	NORMAL (POWER/MODE)
KI7S		SYNCHRO/ FILL-IN	DEMO	OFF (POWER/MODE)

PRINTED CIRCUIT BOARDS

MAIN PCB: M821-MDA1

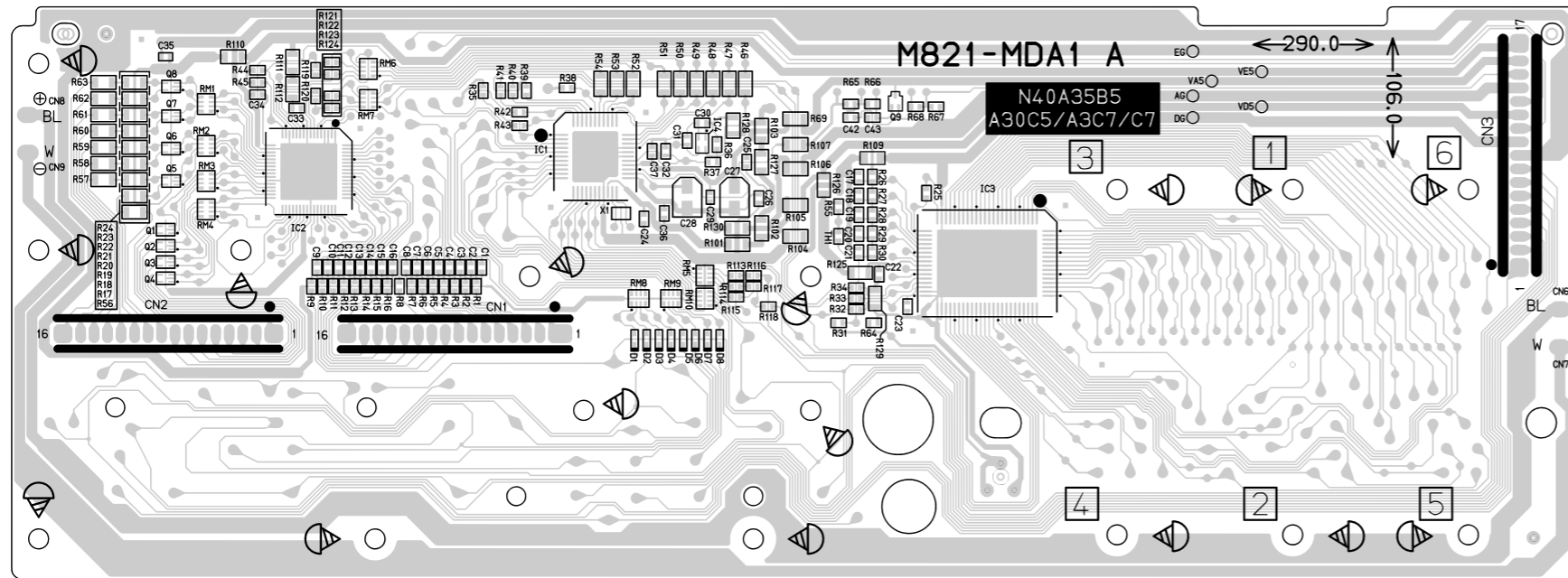

POWER & AMP PCB: M820-PSA1

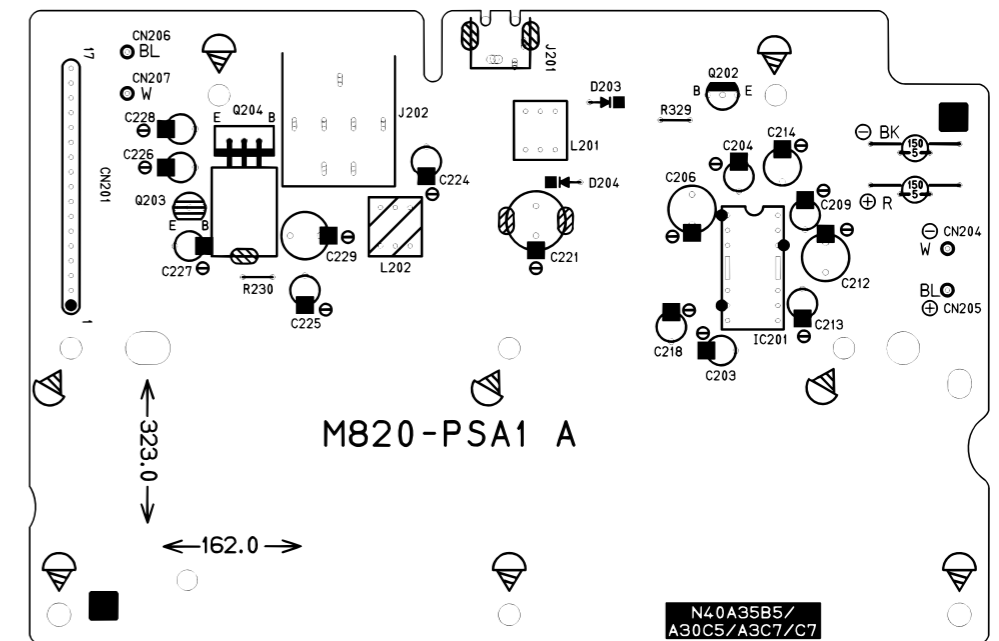
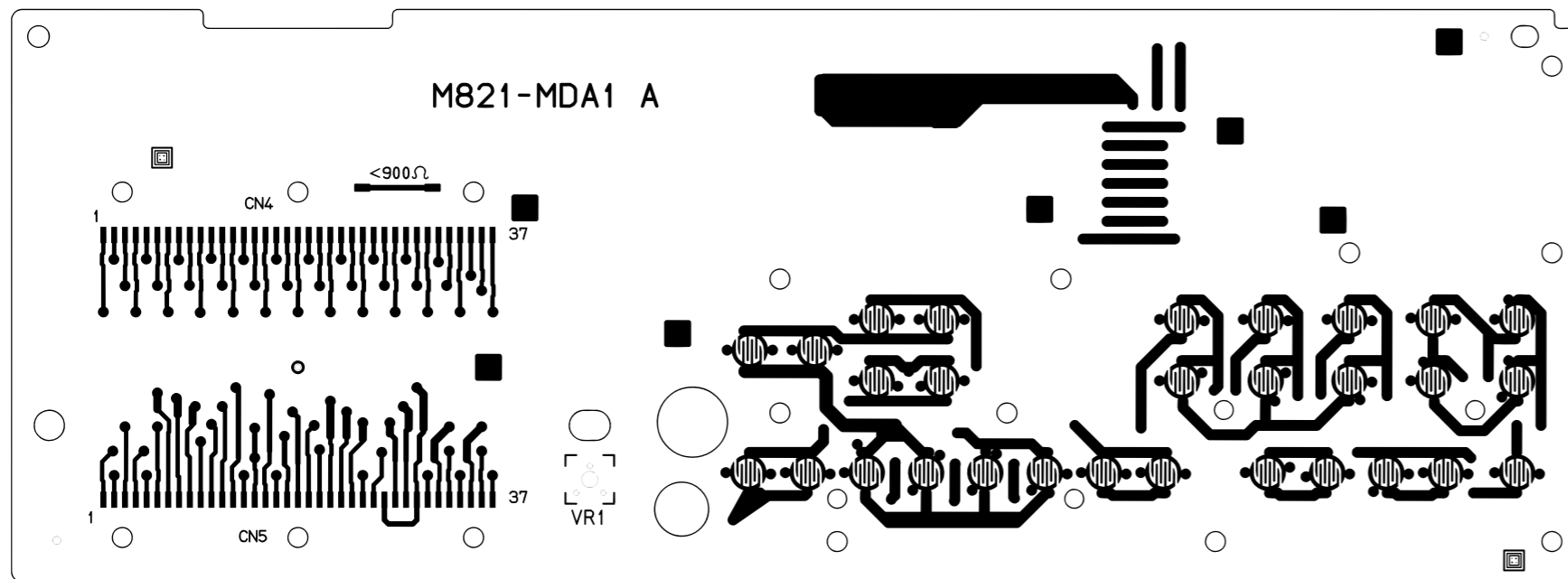
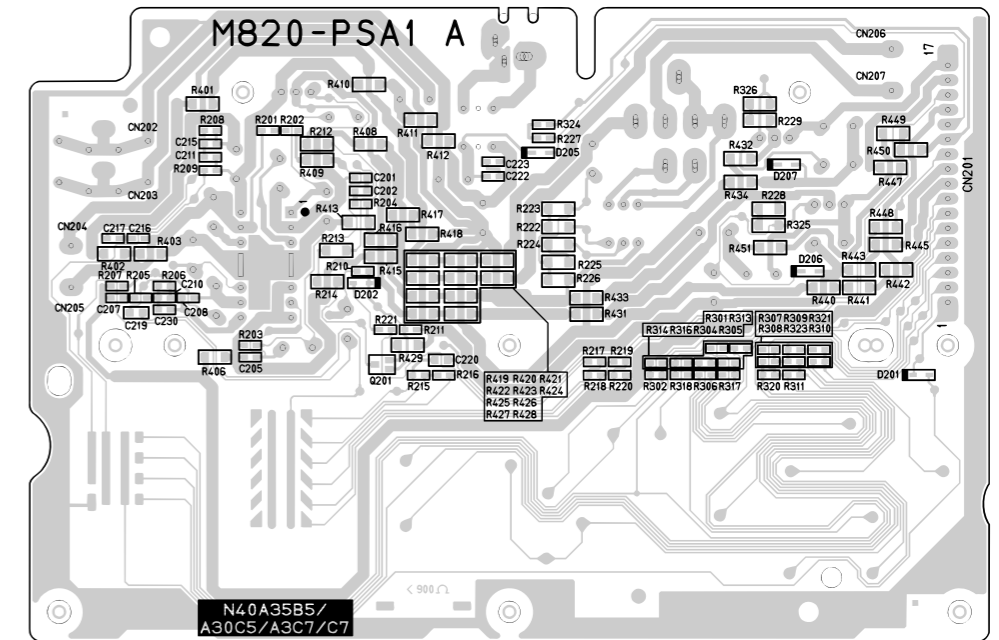

KEYBOARD PCB: M800-KYA1

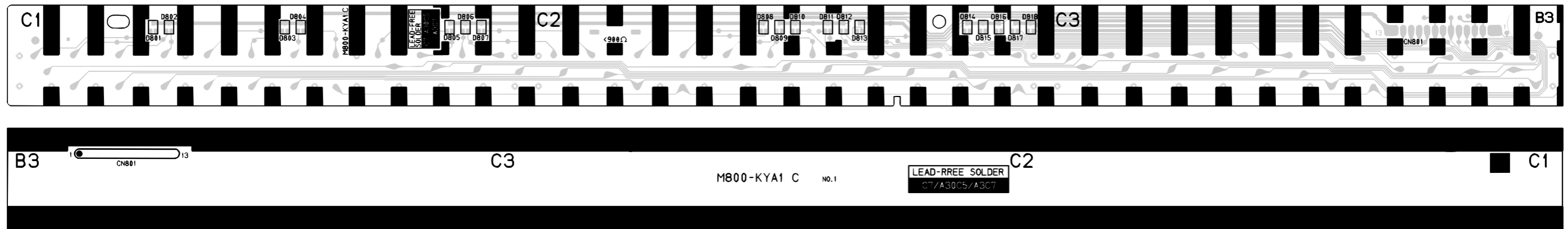

KEYBOARD PCB: M800-KYA2

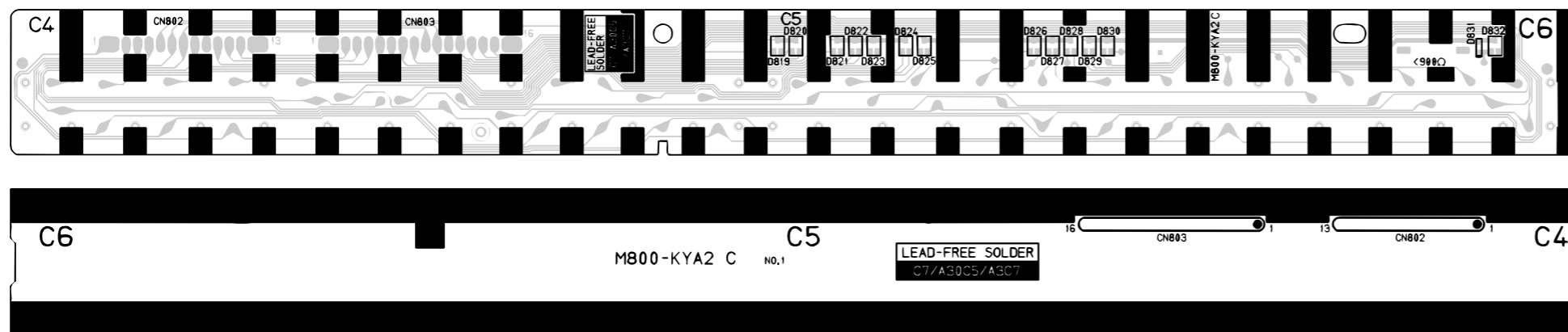

KEYBOARD LED PCB: M821-LDA1

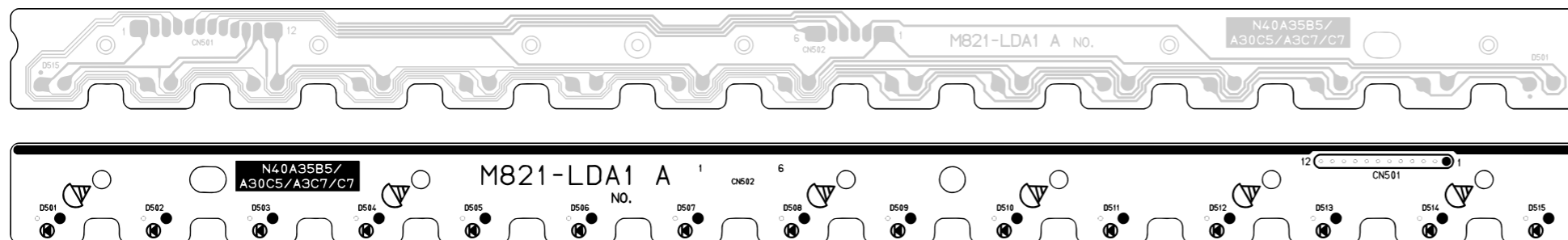

KEYBOARD LED PCB: M821-LDA2

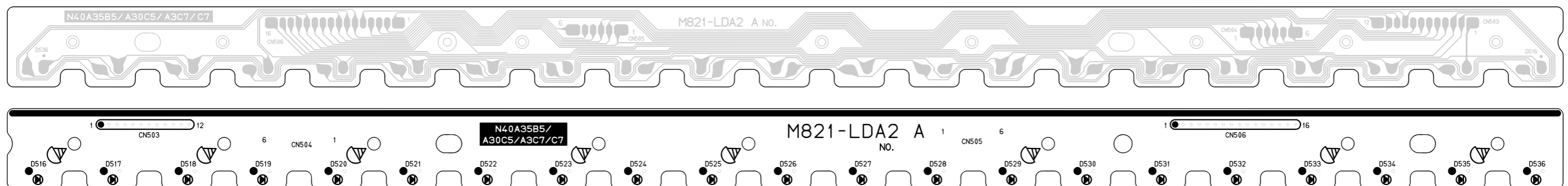

DISASSEMBLY

■ About Repair

- The photos show a prototype. The appearance of the instrument, such as color, may differ from the actual model.
- To avoid damages to the instrument and floor, lay the instrument on a mattress or blanket before starting disassembling.
- There are several kinds of screws. Be sure to use the correct type of screws when reassembling. It is advisable to sort the screws as shown below after removing them.

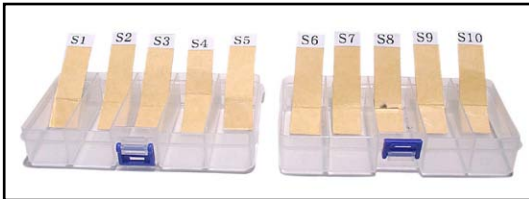

- If a screw cap is attached to the screw, remove it. Be sure to reattach the screw cap when assembling.
- Check how cables are wired before removing cables. Be sure to wire the cables in the same manner as they were before disassembly.
- In case cables are secured with cable ties, securing bands, clips, or tapes, remove them first. Be sure to secure the cables in place in the same manner as they were before disassembly.

■ Before Starting Repair or Servicing

- Remove the AC adaptor, AC cord or batteries.
- Remove accessories such as the music stand.

■ Flowchart

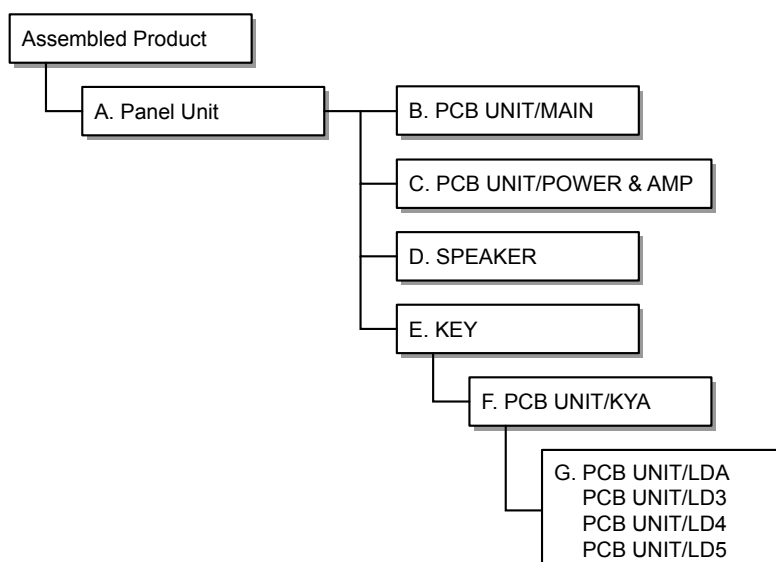

■ Disassembly Procedure

A. Remove the Panel Unit

A-1. Undo 11 screws on the bottom surface of the main unit

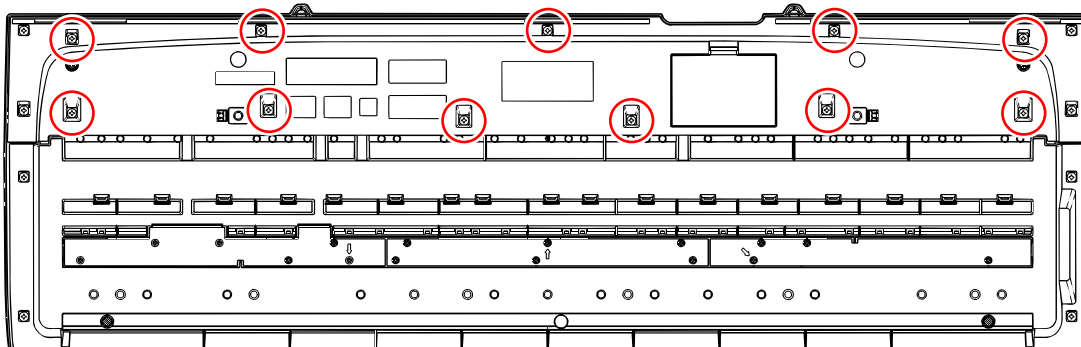

A-2. When replacing the keyboard LED PCB, undo 16 screws and then remove the LOWER COVER.

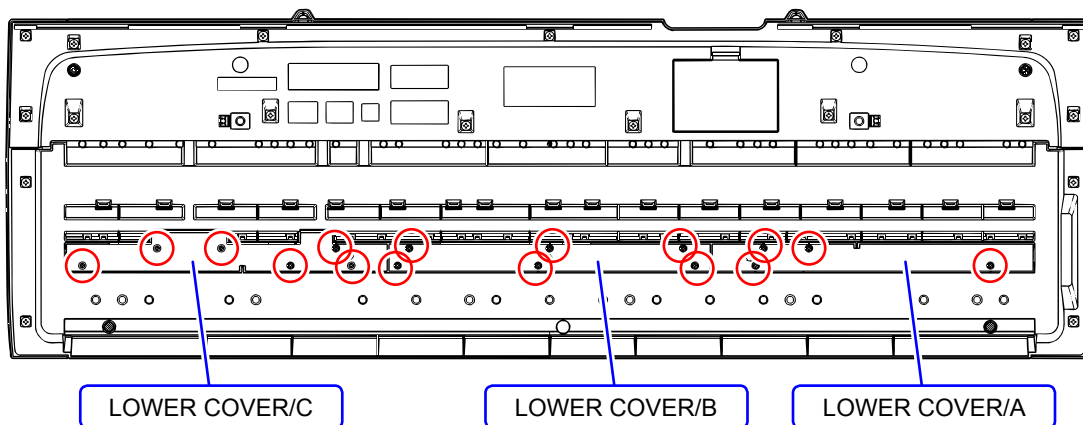

<Notes on Assembly>

- To install the LOWER COVER, tighten the screws indicated with arrows engraved on each cover first.

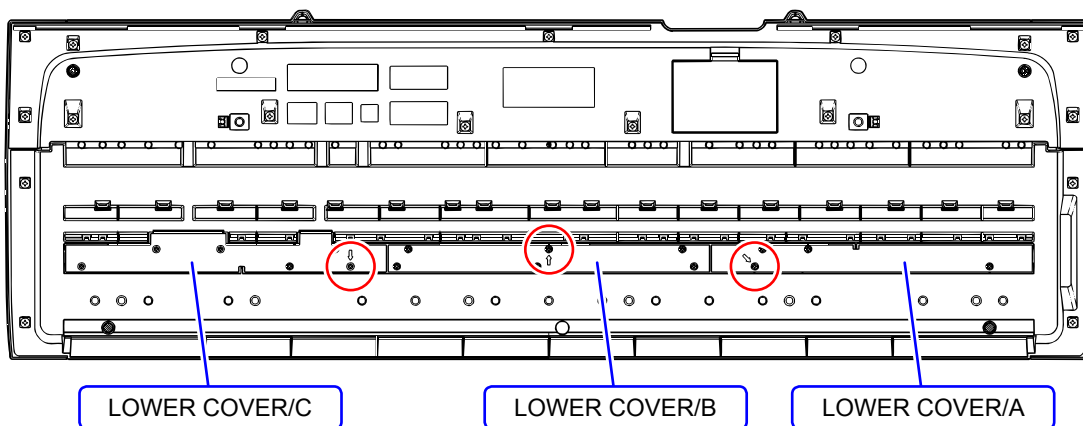

A-3. Turn over the panel unit.

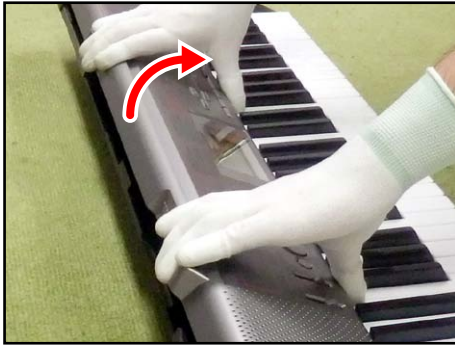

A-4. Unsolder two battery lead wires and two ribbon cables.

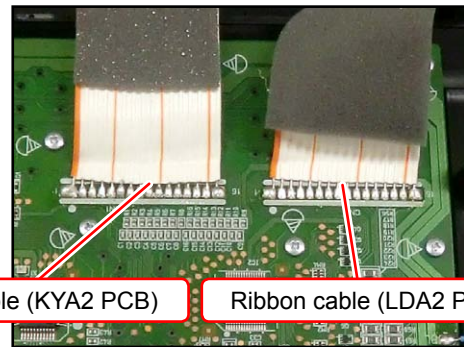
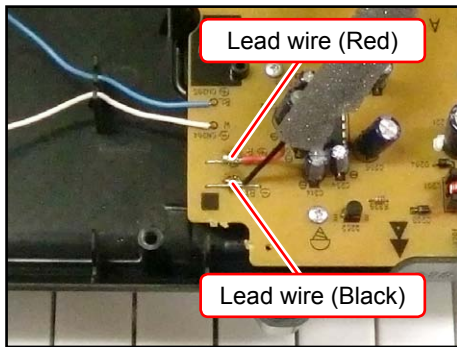

A-5. Remove the panel unit.

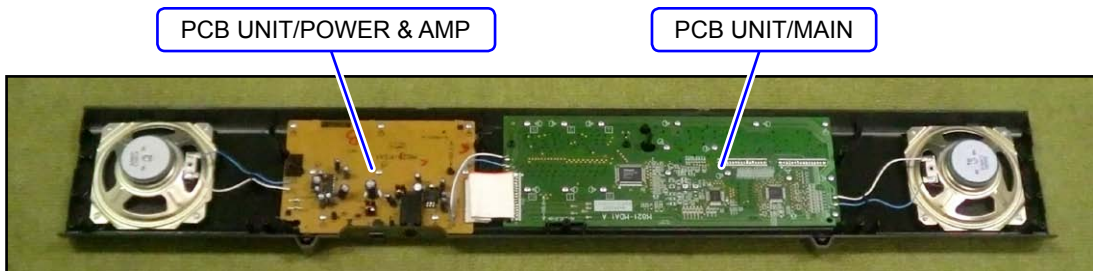

B. Remove the PCB UNIT/MAIN

B-1. Unsolder two ribbon cables.

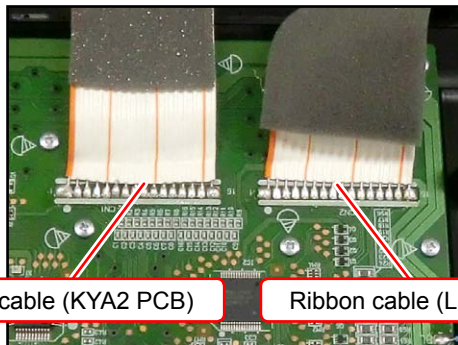

Ribbon cable (KYA2 PCB)

Ribbon cable (LDA2 PCB)

B-2. Unsolder two lead wires and one ribbon cable.

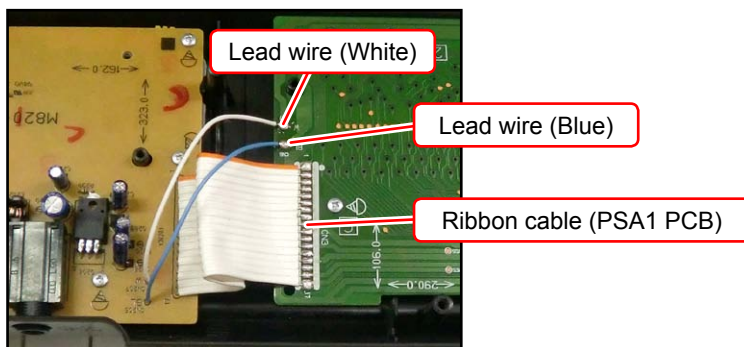

Lead wire (White)

Lead wire (Blue)

Ribbon cable (PSA1 PCB)

B-3. Unsolder two lead wires from the right speaker.

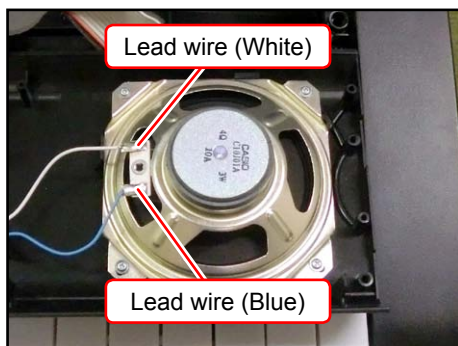

Lead wire (White)

Lead wire (Blue)

B-4. Undo 16 screws and then remove the PCB UNIT/MAIN, four RUBBER KEY, and LCD components.

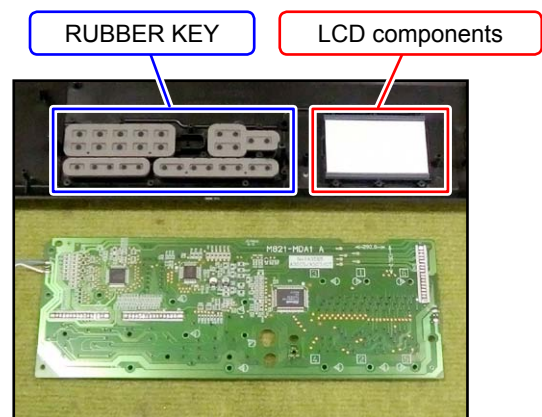
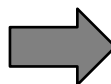
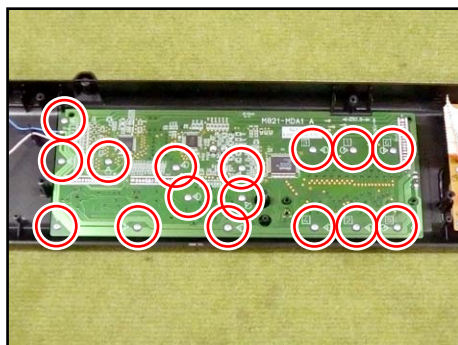

RUBBER KEY

LCD components

<Notes on Assembly>

- To install the MDA1 PCB, tighten the screws for the LCD part in the order shown in the right. If not tighten correctly, it may cause the LCD display errors.

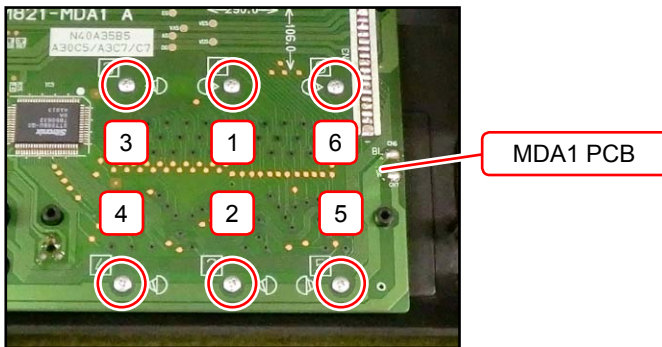

C. Remove the PCB UNIT/POWER & AMP

- C-1. Unsolder two lead wires and one ribbon cable from the MDA1 PCB.

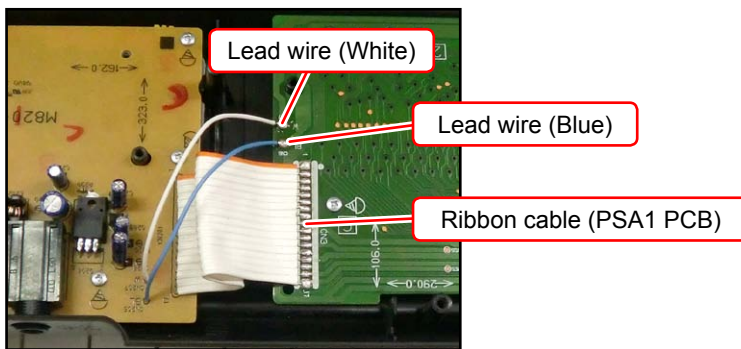

- C-2. Unsolder two lead wires from the left speaker.

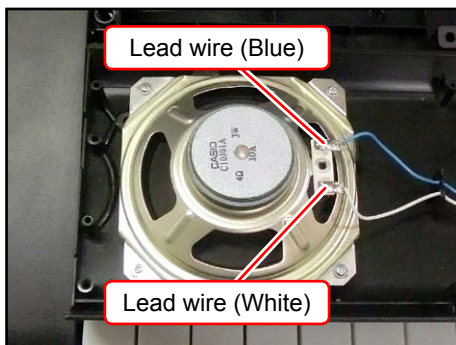

- C-3. Undo eight screws and then remove the PCB UNIT/POWER & AMP, two RUBBER KEY, and two CONTACT/SLIDE SWITCH.

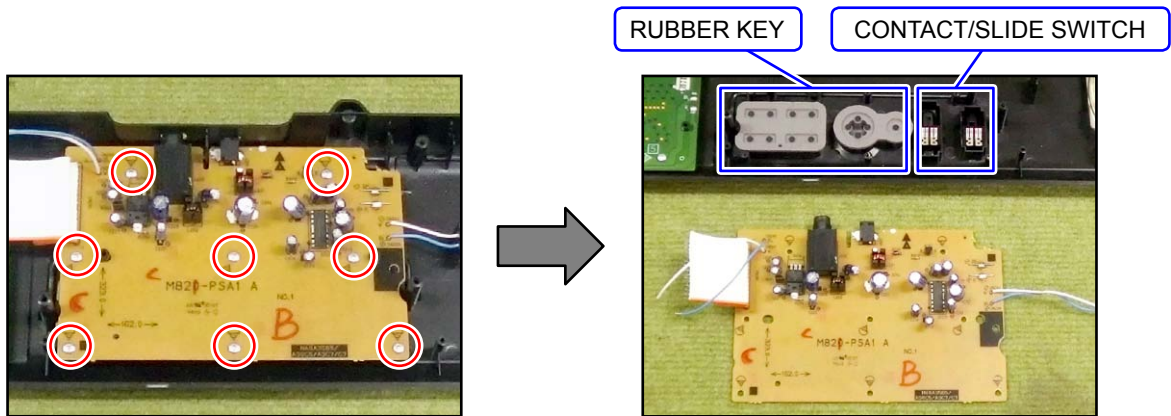

D. Remove the SPEAKER

- D-1. Unsolder two lead wires.
 D-2. Undo four screws and then remove the SPEAKER.

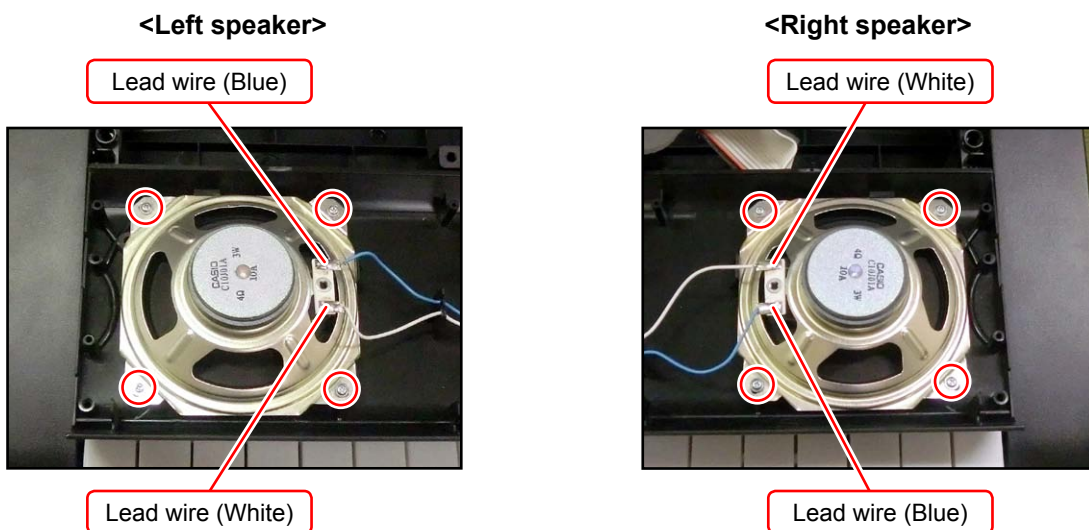

E. KEY

E-1. Undo eight screws and then remove two SIDE PANEL.

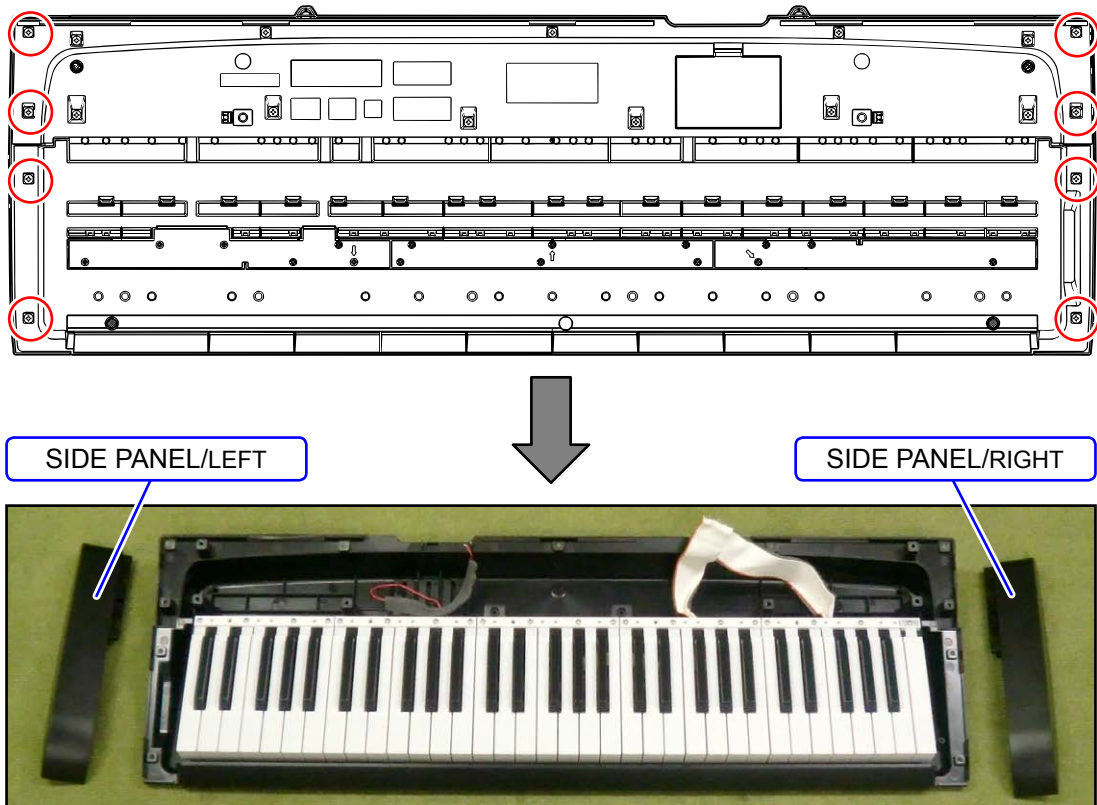

E-2. Undo 21 screws and then remove the KEY.

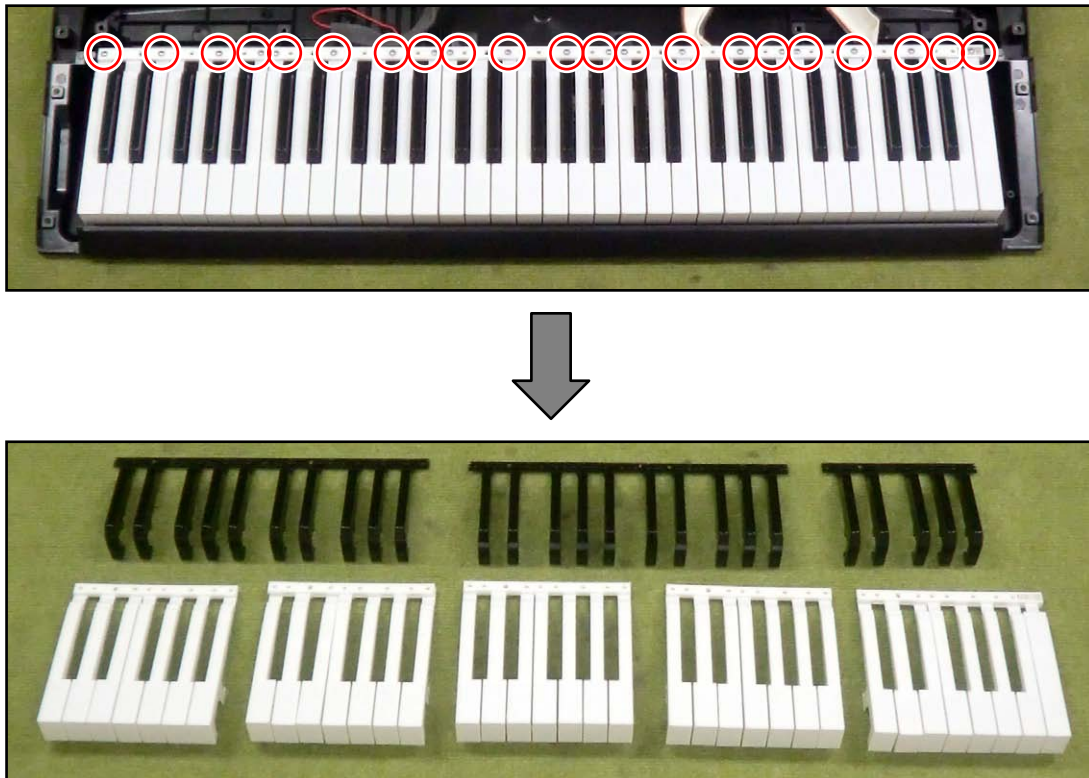

F. Remove the PCB UNIT/KYA

F-1. Disengage the hooks and then remove the PCB UNIT/KYA.

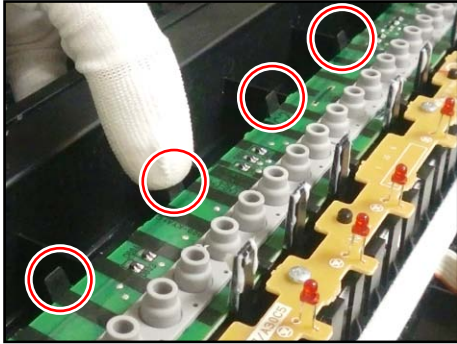

F-2. Remove five RUBBER CONTACT.

NOTE: The RUBBER CONTACT/CS differs from the others in length.

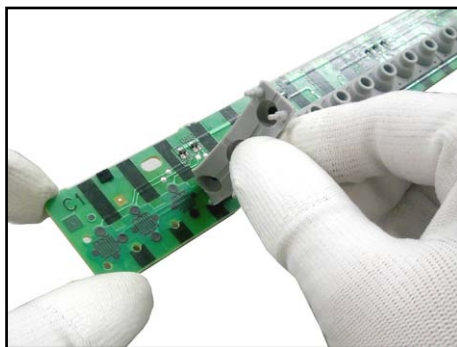
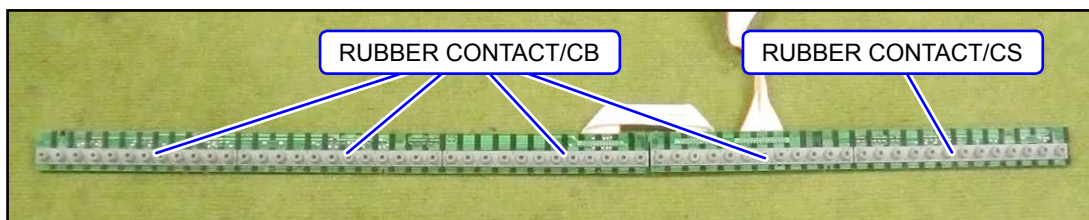

<How to Install RUBBER CONTACT>

- Lightly insert the tip of a RUBBER CONTACT into the PCB. Pull the tip from the back of the PCB and install it using a tool such as tweezers. Do not forcibly pull it.

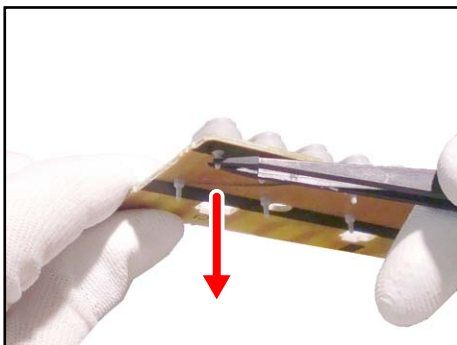

G. Remove the PCB UNIT/LDA, PCB UNIT/LD3, LD4, and LD5

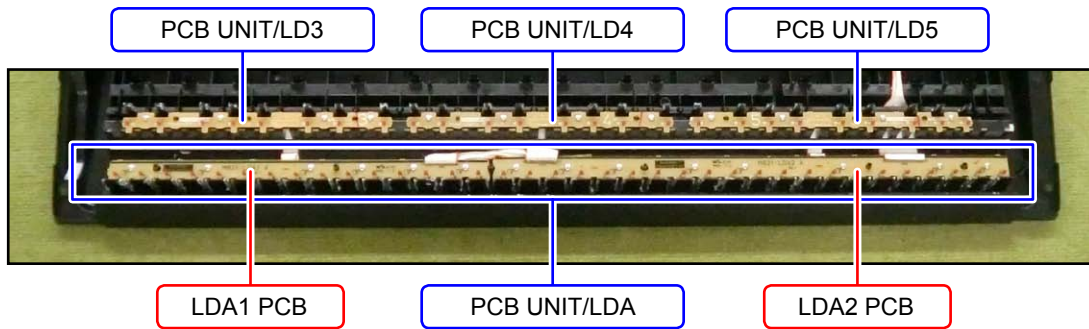

G-1. Undo 14 screws on the LDA1 and LDA2 PCB.

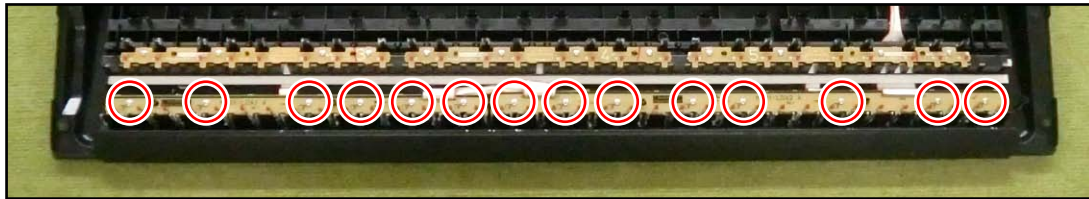

G-2. Turn over the PCB UNIT/LDA.

NOTE: Do not touch the LEDs.

NOTE: After repairing, arrange the ribbon cables again.

G-3. Unsolder three ribbon cables from the LDA1 and LDA2 PCB.

G-4. Undo 12 screws on the LD3, LD4, and LD5 PCB and then remove the PCB UNIT/LDA, PCB UNIT/LD3, LD4, and LD5.

NOTE: After repairing, arrange the ribbon cables again.

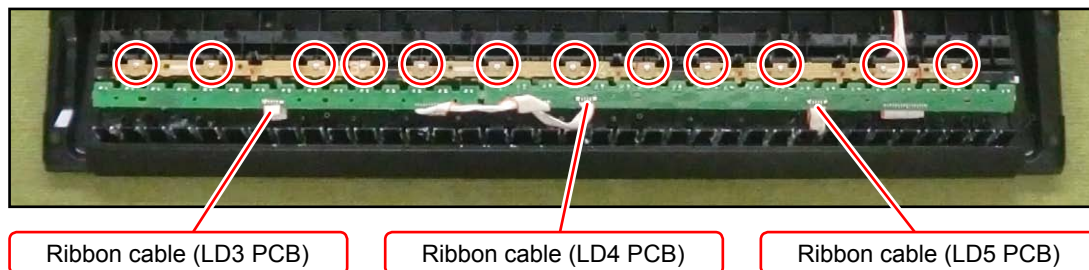

DIAGNOSTIC PROGRAM

■ Preparation

- (1) Connect the AC adaptor.

NOTE: The AC adaptor (AD-E95100L) is sold separately and does not come with the product. If you do not have the AC adaptor, use six AA-size dry batteries with enough capacity.

- (2) Adjust the main volume so that it is at about 1/3 of the full volume.

■ How to Start the Diagnostic Program

- (1) Hold down the “0” and “START/STOP” buttons at the same time, to turn the power ON.

NOTE: Set the mode switch to the “NORMAL”.

NOTE: Be sure to turn OFF the power when the test is finished.

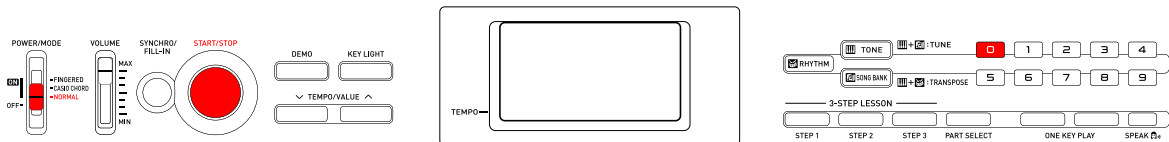

- (2) Release the “0” and “START/STOP” buttons.

After the diagnostic program is launched, the test menu screen appears.

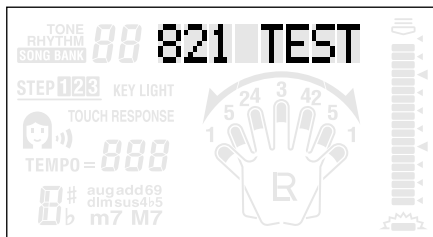

■ Test Items

Pressing a test button enables the corresponding test item to be tested.

Test Items	Buttons	Note
A. Mode Switch Check		
B. Button Check	0	
C. ROM Version Check	1	
D. Keyboard LED Check	TONE	
E. LCD Check	STEP 1	
F. Auto Power OFF Check	PART SELECT	

This diagnostic program does not test the following items.
Check the functions with regular power-on state.

Test Items	Buttons	Note
G. Key Check		
H. Headphones Check		Headphones

■ Test Procedure

A. Mode Switch Check

A-1. Switch the mode switch and then check that the following screen appears.

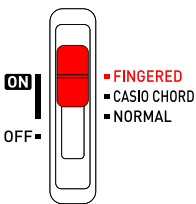
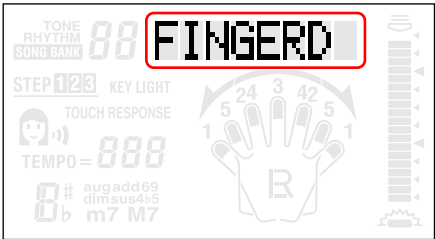
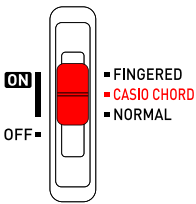
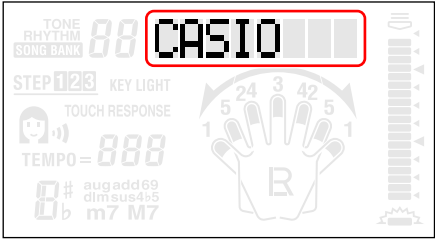
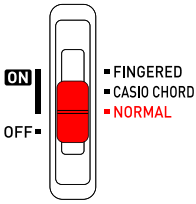
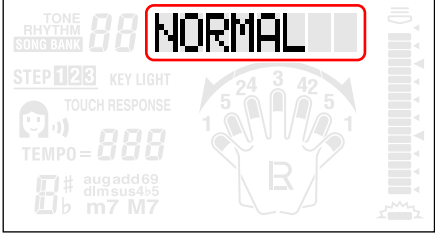
Mode Switch	LCD
<p>FINGERED</p> <p>POWER/MODE</p>  <p>ON</p> <p>OFF</p>	
<p>CASIO CHORD</p> <p>POWER/MODE</p>  <p>ON</p> <p>OFF</p>	
<p>NORMAL</p> <p>POWER/MODE</p>  <p>ON</p> <p>OFF</p>	

B. Button Check

NOTE: You cannot cancel this check procedure mid-way.

B-1. Press the “0” button to select the “Button Check”.

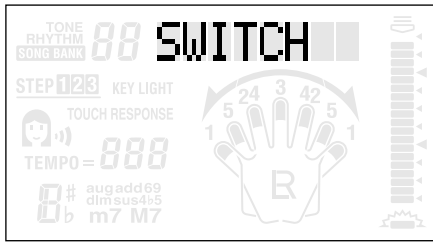

B-2. Press the buttons in the order shown in the figure below.

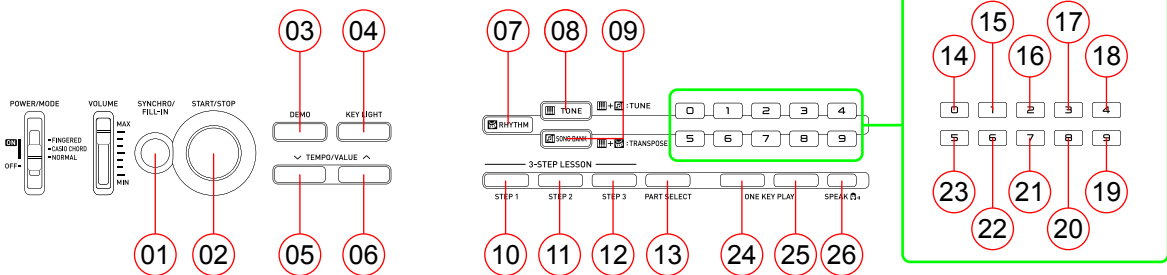

If the result passes (OK):

- The confirmation tone sounds, and the button number and “OK” appear.

If the result fails (NG):

- If there is a button failure or the buttons are pressed in a wrong sequence, the error tone sounds, and the number of the button which you pressed and “NG” will be appear.

B-3. When press the “SPEAK” button at the end, check that the confirmation tone sounds and also that the following screen appears.

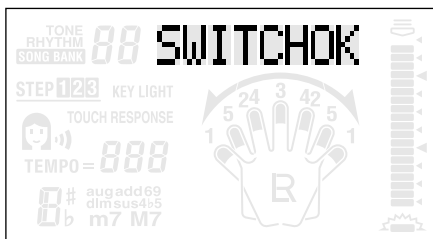

C. ROM Version Check

(This section describes how to identify the ROM version, not to test it.)

C-1. When you press the “1” button, the ROM version appears as shown below.

<Example>

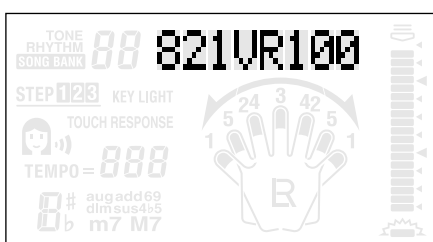

D. Keyboard LED Check

D-1. Press the “TONE” button to perform the “LED Check”.

Automatically the keyboard LEDs are lit.

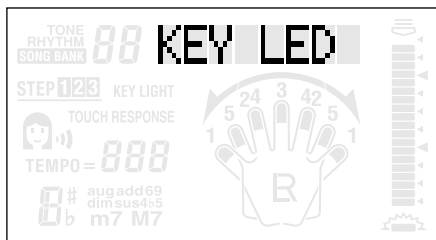

D-2. Check the following points.

- The confirmation tone sounds and the LEDs are lit in the order of numbers shown in the figure below.
- There should be no key of which LED brightness is too bright or too faint.

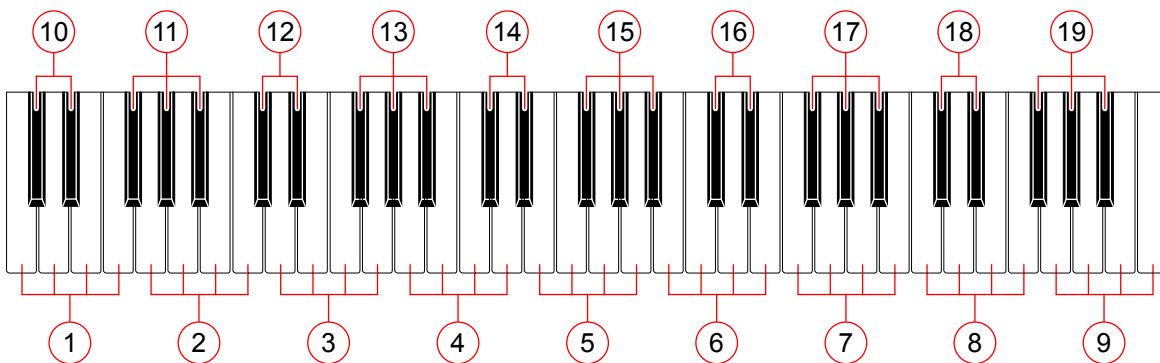

E. LCD Check

E-1. Press the “STEP 1” button to perform the “LCD Check” and then check that the confirmation tone sounds and also that all segments are lit.

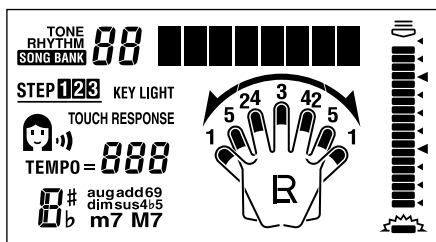

E-2. Press the “STEP 2” button and then check that the confirmation tone sounds and also that all segments are turned OFF.

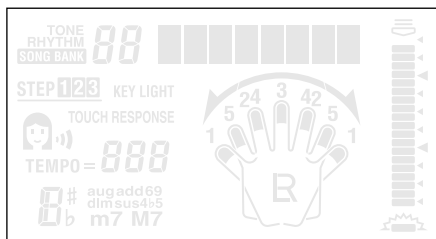

F. Auto Power OFF Check

- F-1. Press the “PART SELECT” button to perform the “Auto Power OFF Check”.
- F-2. Check that the power supply is turned OFF and no screen appears.

NOTE: After checking, be sure to turn the mode switch to “OFF”.

G. Key Check

NOTE: Perform the tests with regular power-on state.

- G-1. Check the following points by pressing all keys.
- The tones sound correctly by hitting keys.
 - The pitch of the sound corresponding to a key is correct.
 - Hitting a key does not produce two tones or make sounds twice.
 - The stroke and the load of keys are normal.
 - The difference in height and the gap between keys are even.

NOTE: Press the keys in the order shown in the figure below.

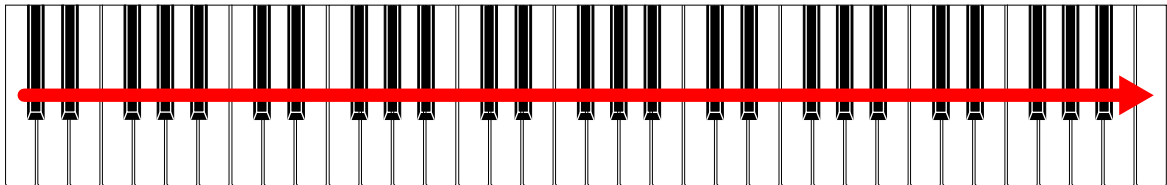

H. Headphones check

NOTE: Perform the tests with regular power-on state.

- H-1. Connect the headphones to the PHONES/OUTPUT jack.
- H-2. Press any key and then check that you can hear the sound through the headphones.
- H-3. Remove the headphones.
- H-4. Press any key and then check that sounds come out from the speakers.

PARTS LIST

LK-127

Notes:

1. Prices and specifications are subject to change without prior notice.
2. Refer to the latest "Parts Price Code" at "PARTS FINDER" on the Casio Service WEB site (<https://www.servicecasio.com>).
3. As for spare parts order and supply, refer to the "GUIDEBOOK for Spare Parts Supply", published separately.
4. The numbers in item column correspond to the same numbers in drawing.

EXPLODED VIEW

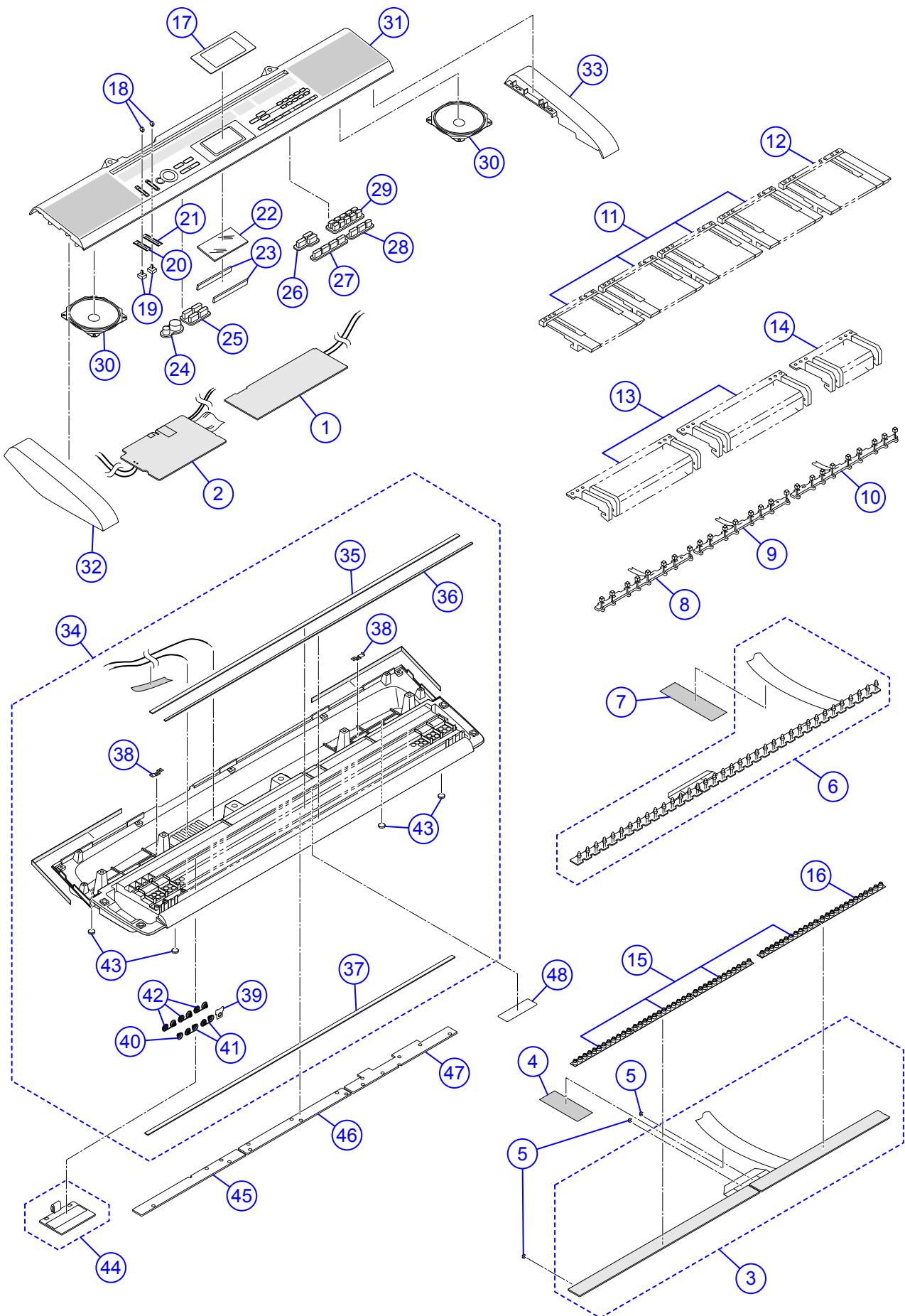

- 1: LK-127_DI
- 2: LK-127_EU
- 3: LK-127_US

N	Item	Code No.	Parts Name	Specification	Q'ty			R	Remarks
					1	2	3		
MAIN PCB									
	1	10368210	PCB UNIT/MAIN	TK-RJM510419*001	1	1	1	B	MDA1
	CN8	10178633	WIRE/BLUE	1007TASC24100B4040	1	1	1	X	for Speaker (+)
	CN9	10366747	WIRE/WHITE	1007TASC24100W4040	1	1	1	X	for Speaker (-)
	VR1	69304870	VARIABLE RESISTOR	EVND8AA03B53	1	1	1	X	for LCD contrast
	D1-D8	10276977	DIODE	L1SS400T1G	8	8	8	X	
	IC4	10240586	IC	XC6109N40ANR	1	1	1	X	
	IC1	10363062	LSI	ML6756B32GAZ03A114	1	1	1	C	
	IC3	10222381	LSI	ST7066U-0A-QG	1	1	1	C	
	IC2	10159709	LSI	UPD65881GK-1019ETA	1	1	1	C	
	Q9	69300298	TRANSISTOR	2SC4081T106R	1	1	1	X	
	Q5-Q8	10209018	TRANSISTOR	KTA501U-GR-RTK/P	4	4	4	X	
	Q1-Q4	10207076	TRANSISTOR	KTC601U-GR-RTK/P	4	4	4	X	
	TH1	10138692	THERMISTOR	NCP18XH103J03RB	1	1	1	X	
	X1	10070555	RESONATOR	CSTCW20M0X51-R0	1	1	1	X	
POWER & AMP PCB									
	2	10368211	PCB UNIT/POWER & AMP	TK-RJM510421*001	1	1	1	C	PSA1
	CN205,CN206	10178633	WIRE/BLUE	1007TASC24100B4040	2	2	2	X	for Speaker (+)
	CN204,CN207	10366747	WIRE/WHITE	1007TASC24100W4040	2	2	2	X	for Speaker (-)
	J201	35015103	JACK/DC	HEC3110-01-010	1	1	1	B	
	J202	10305218	JACK/PHONES	JY-6316B*01-070	1	1	1	C	
	IC201	10300598	IC	TA8227APL-D12-H-T	1	1	1	X	
	L202	10231919	COIL	RB53-856396NP	1	1	1	X	
	L201	10231920	COIL	RB53-856397NP	1	1	1	X	
	D203,D204	10261170	DIODE	SRT14-A2	2	2	2	X	
	D206,D207	79114195	DIODE	UDZSTE-175.6B	2	2	2	X	
	D201,D202	10371167	DIODE	L1SS355T1G	2	2	2	X	
	Q204	10206676	TRANSISTOR	KTC2026-Y-U/P	1	1	1	X	
	Q201	69300298	TRANSISTOR	2SC4081T106R	1	1	1	X	
	Q202	10217742	TRANSISTOR	KTA1270-Y-AT/P	1	1	1	X	
	Q203	10209015	TRANSISTOR	KTD863-GR-AT/P	1	1	1	X	

- 1: LK-127_DI
- 2: LK-127_EU
- 3: LK-127_US

N	Item	Code No.	Parts Name	Specification	Q'ty			R	Remarks
					1	2	3		
KEYBOARD PCB									
N	3	10368208	PCB UNIT/KYA	TK-RJM508609*002	1	1	1	C	KYA1/KYA2
	D801-D830,D832	10301580	DIODE	LM1MA142WAT1G	31	31	31	X	
	4	69261580	SPONGE/35X150	M440499-1	1	1	1	X	
	5	69268840	FABRIC TAPE/4X10	M440684-1	3	3	3	X	
	6	10368212	PCB UNIT/LDA	TK-RJM510423*001	1	1	1	C	
	D501-D536	10302396	LED	1154SURDKB5/7.5-90	36	36	36	X	
	7	10263729	SPONGE/43X180	M441123-001V01	1	1	1	X	
	8	10453355	PCB UNIT/LD3	TK-M240428*012	1	1	1	C	
	LED451-LED458	10302396	LED	1154SURDKB5/7.5-90	8	8	8	X	
	9	10453356	PCB UNIT/LD4	TK-M240429*012	1	1	1	C	
LED459-LED466	10302396	LED	1154SURDKB5/7.5-90	8	8	8	X		
10	10453357	PCB UNIT/LD5	TK-M240430*012	1	1	1	C		
LED467-LED475	10302396	LED	1154SURDKB5/7.5-90	9	9	9	X		
KEYBOARD UNIT									
	11	10304700	WHITE KEY/CB	TK-RJM507243*003	4	4	4	C	
	12	10304699	WHITE KEY/CS	TK-RJM507244*003	1	1	1	C	
	13	10301442	BLACK KEY/10P	RJM506595-009V02	2	2	2	C	
	14	10301443	BLACK KEY/5P	RJM506595-010V02	1	1	1	C	
	15	10163902	RUBBER CONTACT/CB	RJM503854-001V01	4	4	4	B	
	16	10163903	RUBBER CONTACT/CS	RJM503855-001V01	1	1	1	B	
PANEL UNIT									
N	17	10451540	PLATE/DISPLAY	RJM510316-006V02	1	1	1	X	
	18	10301435	KNOB/SLIDE SWITCH	RJM503803-009V01	2	2	2	X	
	19	69095890	CONTACT/SLIDE SWITCH	CSB-12D	2	2	2	X	
	20	10417026	FABRIC TAPE	RJM511849-001V01	1	1	1	X	
	21	10417025	FABRIC TAPE	RJM511833-001V01	1	1	1	X	
	22	10272509	LCD	SDT-M4396-RP-0	1	1	1	X	
	23	10366853	RUBBER CONNECTOR	RJM510317-001V01	2	2	2	X	
N	24	10451350	RUBBER KEY/A	RJM510262-003V01	1	1	1	X	
N	25	10451351	RUBBER KEY/B	RJM510264-003V01	1	1	1	X	

- 1: LK-127_DI
- 2: LK-127_EU
- 3: LK-127_US

N	Item	Code No.	Parts Name	Specification	Q'ty			R	Remarks
					1	2	3		
N	26	10451352	RUBBER KEY/C	RJM510282-009V01	1	1	1	X	
N	27	10451353	RUBBER KEY/D	RJM510283-003V01	1	1	1	X	
N	28	10451354	RUBBER KEY/E	RJM510284-003V01	1	1	1	X	
N	29	10451355	RUBBER KEY/F	RJM510285-002V01	1	1	1	X	
	30	10264808	SPEAKER	C10J01A	2	2	2	X	
N	31	10451349	PANEL	RJM510265-010V01	1	1	1	X	
N	32	10451337	SIDE PANEL/LEFT	RJM510267-002V01	1	1	1	X	
N	33	10451338	SIDE PANEL/RIGHT	RJM510268-002V01	1	1	1	X	
MAIN CASE UNIT									
N	34	10453358	CASE UNIT/MAIN	TK-RJM510380*002	1	1	1	X	
	35	10301471	FELT/LOWER LIMIT/KEYBOARD	RJM508593-001V01	1	1	1	X	
	36	10317116	FELT/DAMPER/KEYBOARD	RJM509138-001V01	1	1	1	X	
	37	10205015	FELT/UPPER LIMIT/KEYBOARD	M440342-001V02	1	1	1	X	
	38	10284332	BRACKET/for Stand	M440866-001V02	2	2	2	X	
	39	69271080	BATTERY SPRING/(+)	M440112-1	1	1	1	X	
	40	10274835	BATTERY SPRING/(-)	M440002-001V02	1	1	1	X	
	41	69271060	BATTERY SPRING/A	M440676-1	2	2	2	X	
	42	69271070	BATTERY SPRING/B	M440677-1	3	3	3	X	
	43	69226920	RUBBER FOOT	M41361-6	4	4	4	X	
	44	10404576	BATTERY COVER	TK-M340884*031	1	1	1	X	
	45	10329837	LOWER COVER/A	RJM508655-001V03	1	1	1	X	
	46	10329838	LOWER COVER/B	RJM508656-001V03	1	1	1	X	
	47	10329839	LOWER COVER/C	RJM508657-001V03	1	1	1	X	
N	48	10451341	RATING LABEL	RJM504373-102V02	1	1	1	X	
ACCESSORY									
	-	10366857	MUSIC STAND	RJM510426-001V01	1	1	1	C	

SCHEMATIC DIAGRAMS

MAIN PCB: M821-MDA1

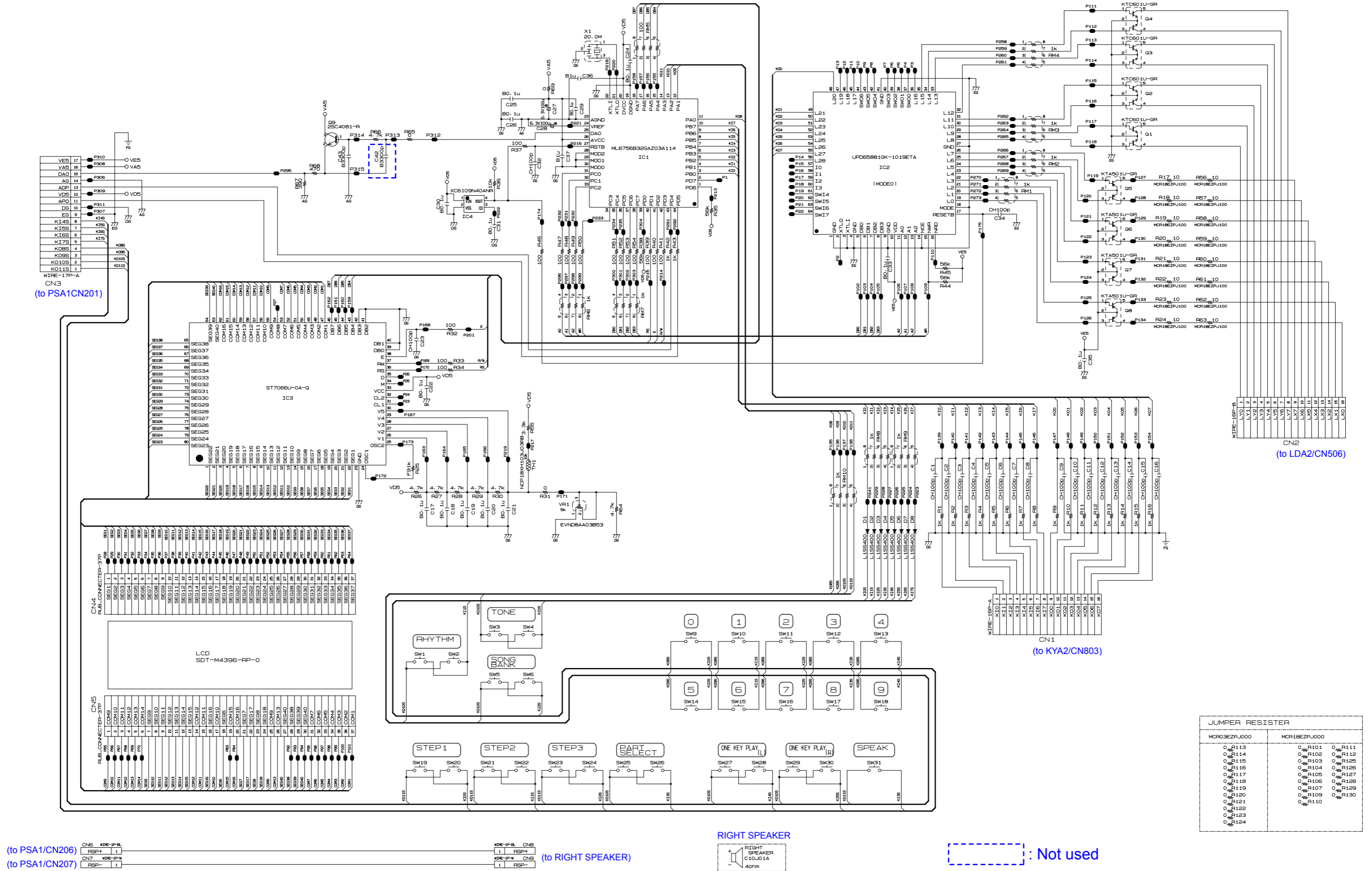

POWER & AMP PCB: M820-PSA1

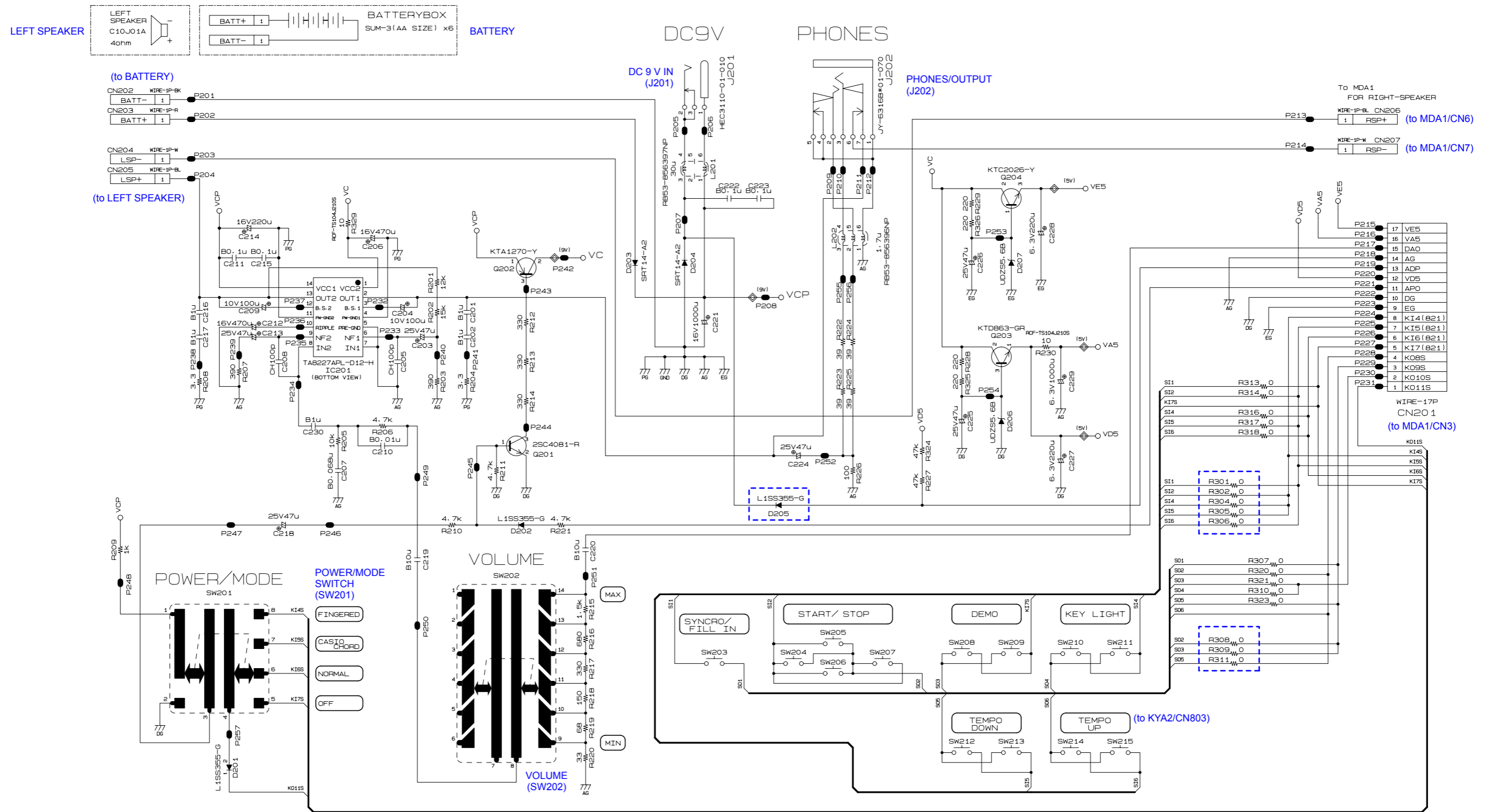

JUMPER RESISTOR

0 _W R401	0 _W R411	0 _W R421	0 _W R431	0 _W R441
0 _W R402	0 _W R412	0 _W R422	0 _W R432	0 _W R442
0 _W R403	0 _W R413	0 _W R423	0 _W R433	0 _W R443
0 _W R406	0 _W R415	0 _W R424	0 _W R434	0 _W R445
0 _W R408	0 _W R416	0 _W R425	0 _W R440	0 _W R447
0 _W R409	0 _W R417	0 _W R426		0 _W R448
0 _W R410	0 _W R418	0 _W R427		0 _W R449
0 _W R411	0 _W R419	0 _W R428		0 _W R450
	0 _W R420	0 _W R429		0 _W R451

Not used

KEYBOARD PCB: M800-KYA1/KYA2

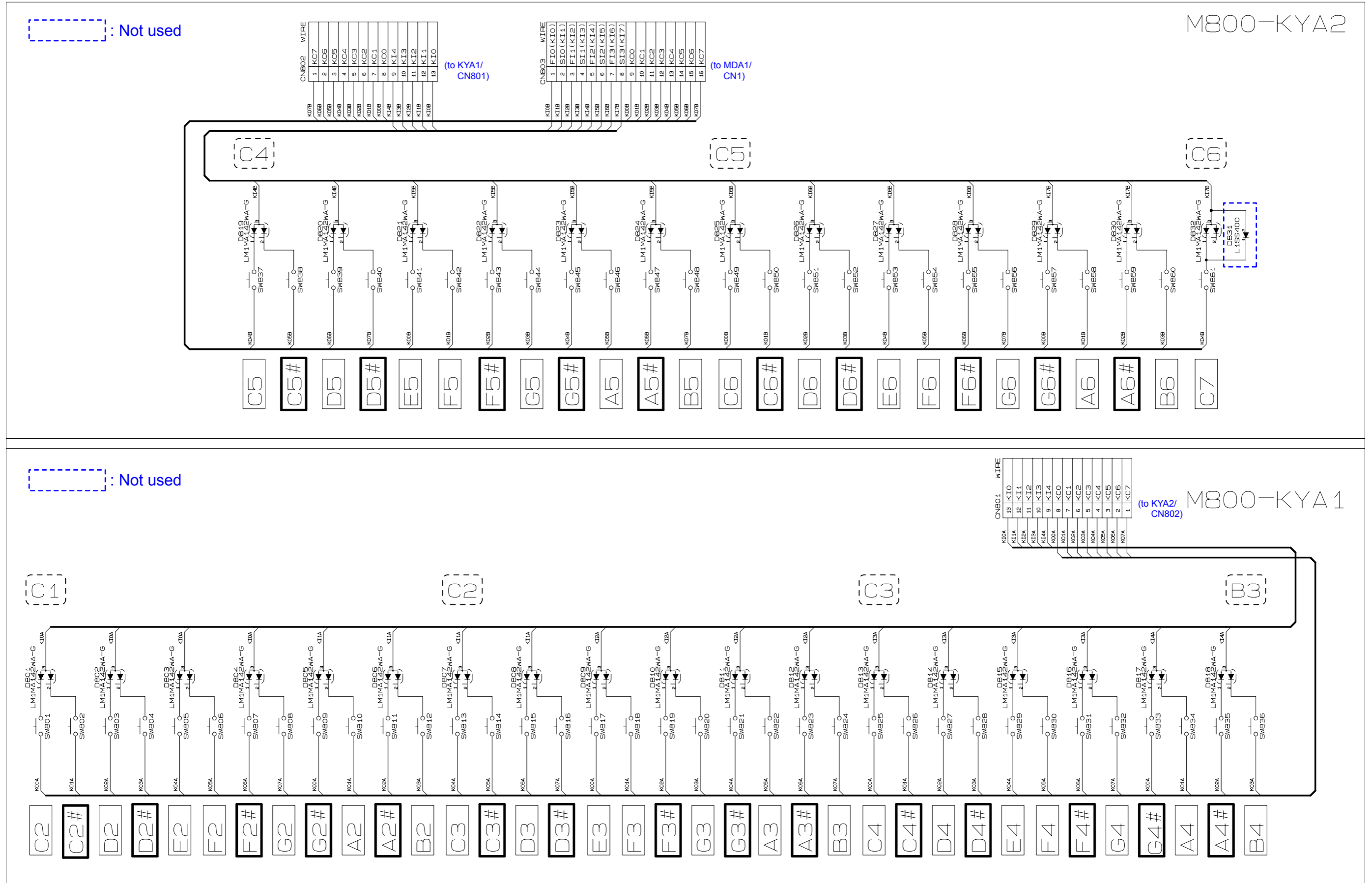

KEYBOARD LED PCB: M821-LDA1

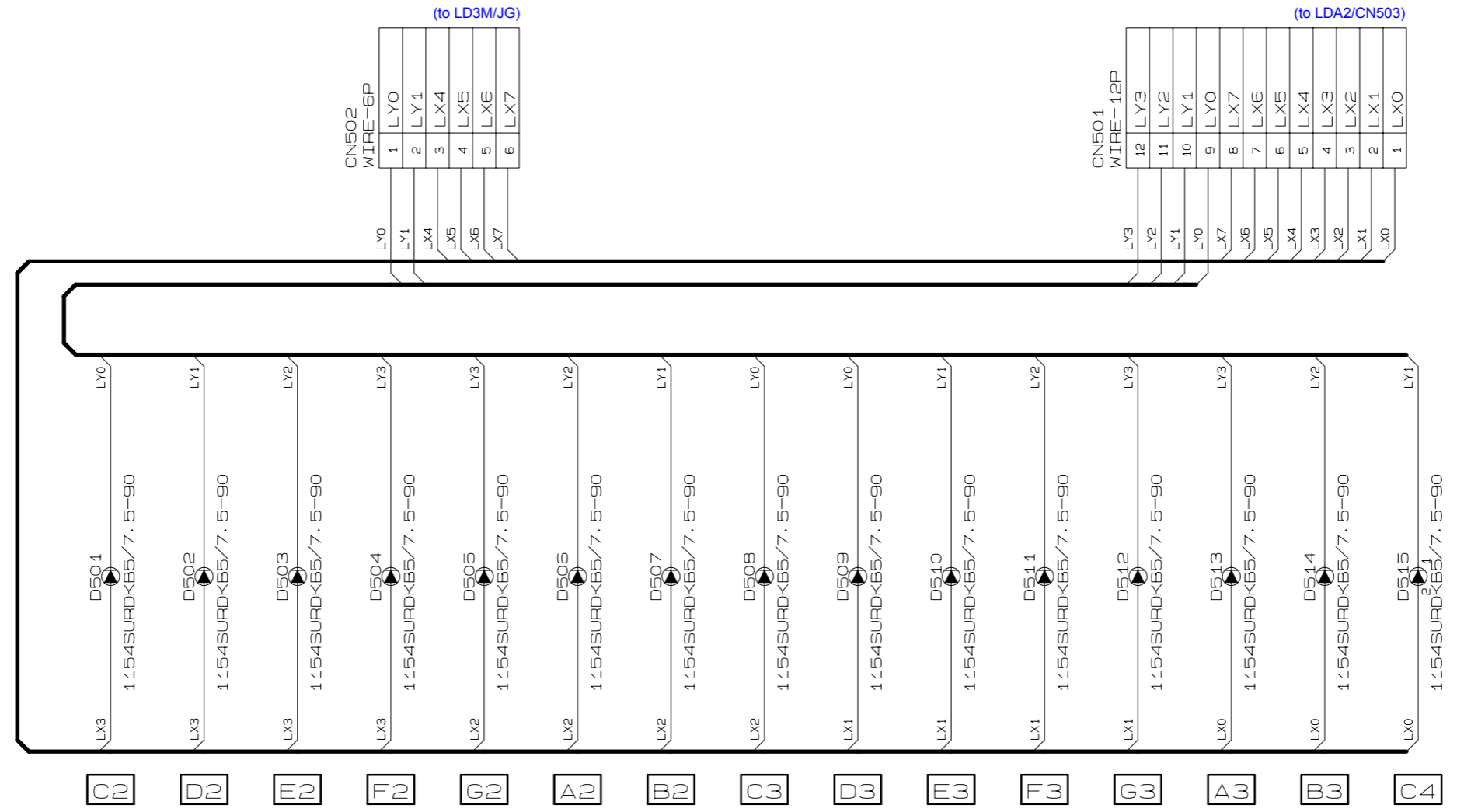

(to LD3M/JG)

(to LDA2/CN503)

KEYBOARD LED PCB: M821-LDA2

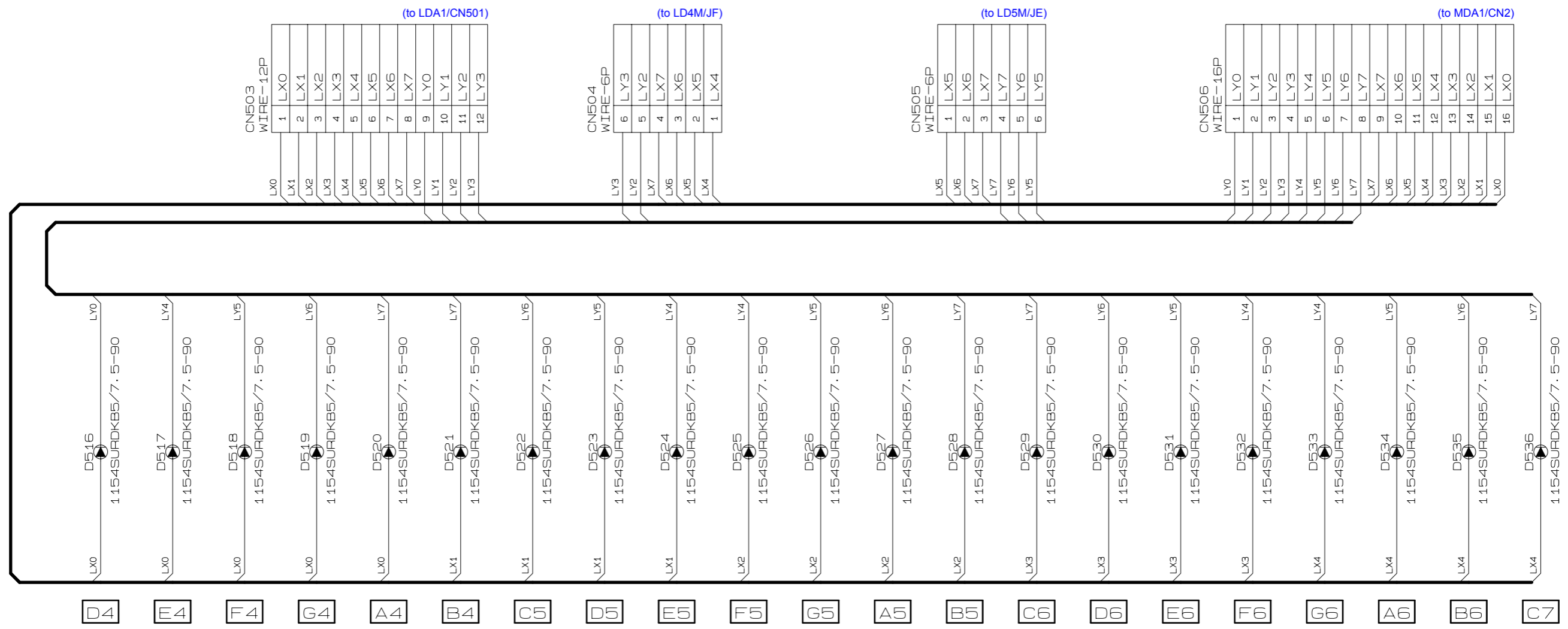

KEYBOARD LED PCB: CSM446-LD3M / LD4M / LD5M

CSM446-LD3M

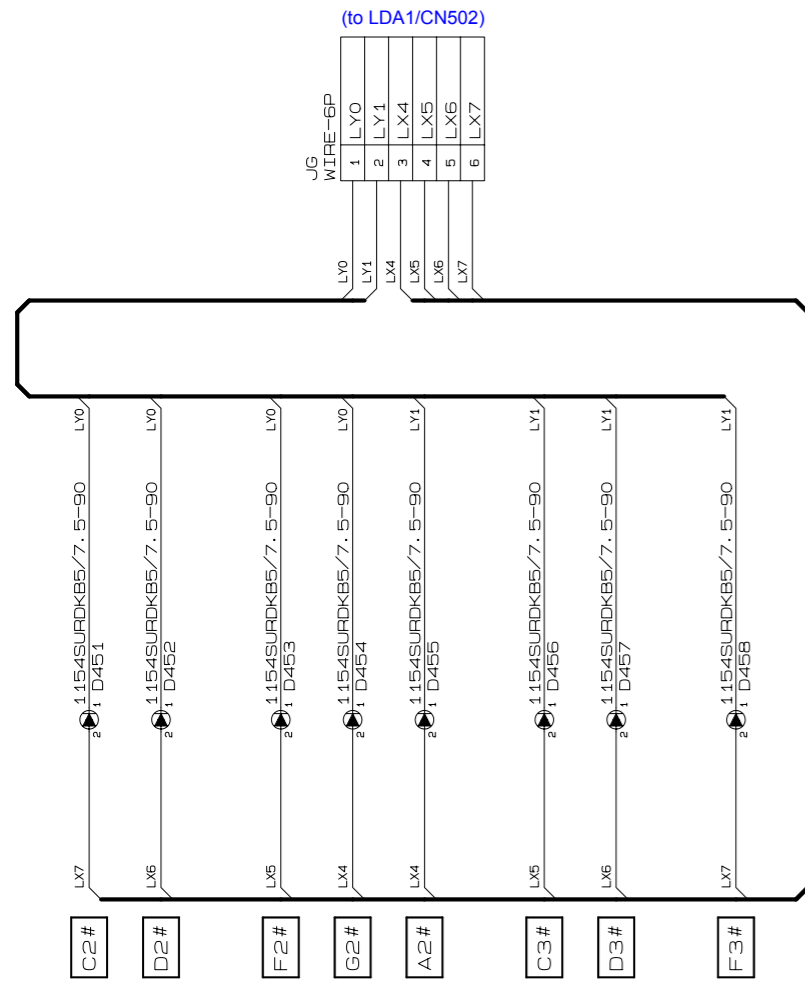

CSM446-LD4M

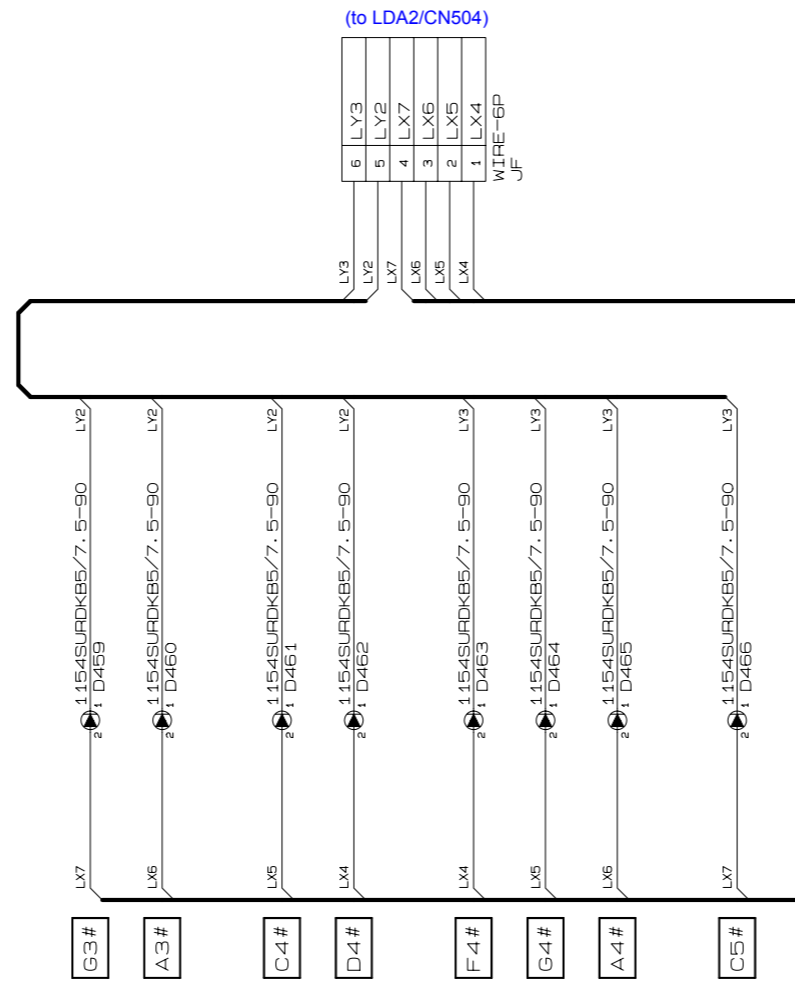

CSM446-LD5M

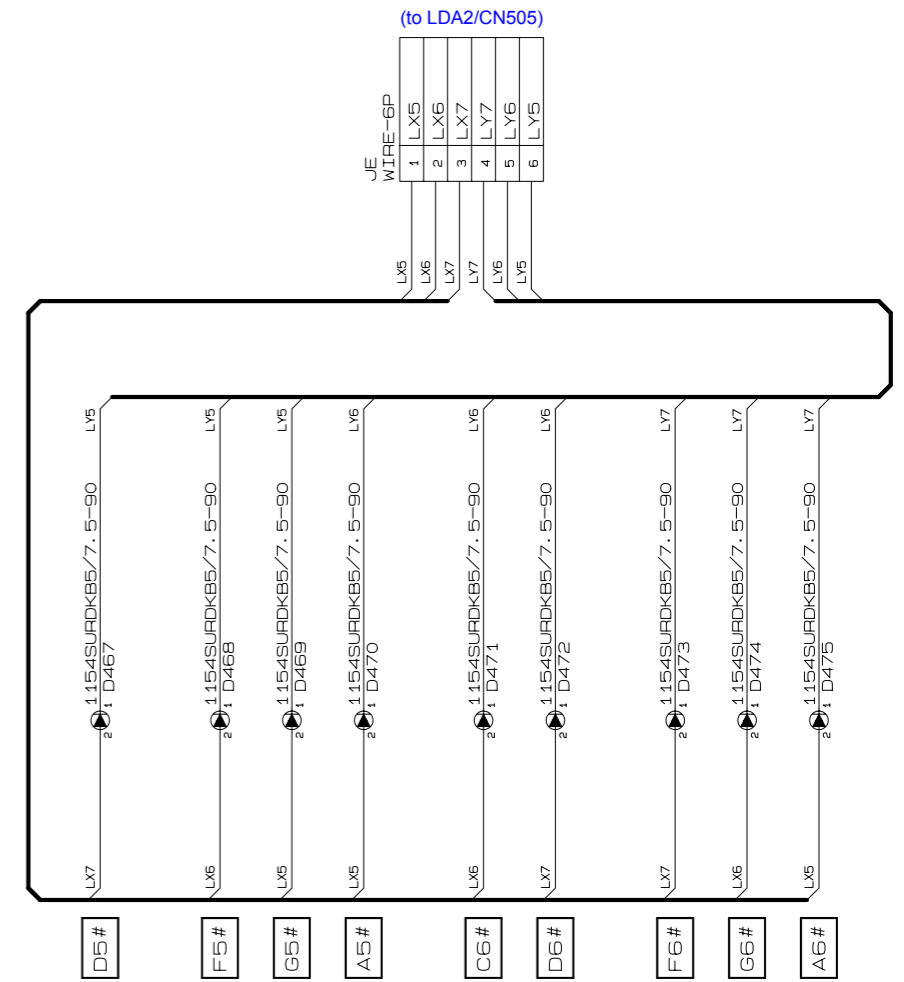

CASIO COMPUTER CO., LTD.

CS Technical Department

TOKYO, JAPAN