

# CASIO®

# SERVICE MANUAL & PARTS LIST

(without price)

## WK-220

JUN. 2011

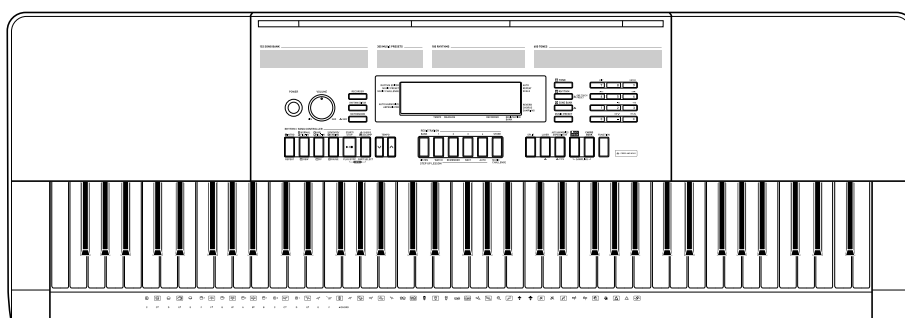

WK-220

**ELECTRONIC KEYBOARD**

Ver. 4 : Jul. 2014

## CONTENTS

SPECIFICATIONS.....	1
BLOCK AND WIRING DIAGRAM .....	3
PCB INFORMATION .....	4
CIRCUIT DESCRIPTION .....	5
PRINTED CIRCUIT BOARDS.....	7
DISASSEMBLY .....	10
DIAGNOSTIC PROGRAM .....	20
EXPLODED VIEW.....	29
PARTS LIST.....	31
SCHEMATIC DIAGRAMS.....	34

## SPECIFICATIONS

<b>Keyboard</b>	76 standard size keys
<b>Touch Response</b>	2 types, Off
<b>Maximum Polyphony</b>	48 notes (24 for certain tones)
<b>Tones</b>	
<b>Built-in Tones</b>	600
<b>Sampling Tones</b>	Up to 8 (Melody Sampling: 5, Drum Sampling: 3)* Up to 10 seconds
<b>Functions</b>	Layer, Split, Piano/Organ button
<b>Reverb</b>	1 to 10, Off
<b>Chorus</b>	1 to 5, Off
<b>Metronome</b>	
<b>Beats per Measure</b>	0, 2 to 6
<b>Tempo Range</b>	30 to 255
<b>Song Bank</b>	
<b>Built-in Songs</b>	152
<b>User Songs</b>	Up to 10*
<b>Step Up Lesson</b>	
<b>Lessons</b>	4 (Listen, Watch, Remember, Auto)
<b>Lesson Part</b>	L, R, LR
<b>Functions</b>	Repeat, Voice Fingering Guide, Note Guide, Performance Evaluation
<b>Music Challenge</b>	20 notes
<b>Auto Accompaniment</b>	
<b>Built-in Rhythms</b>	180
<b>User Rhythms</b>	Up to 10 (Accompaniment Edit)*
<b>Chord Book Function</b>	Chord guide
<b>Registration</b>	32 (4 setups × 8 banks)
<b>Recorder</b>	Real-time recording, playback
<b>Keyboard Play</b>	5 songs, 6 tracks
<b>Playing Along with a Built-in Songs</b>	1 song (L, R, LR)
<b>Memory Capacity</b>	Approximately 12,000 notes (total for 6 songs)
<b>Other Functions</b>	
<b>Transpose</b>	±1 octaves (-12 to +12 semitones)
<b>Octave Shift</b>	Upper/Lower ±2 octaves
<b>Tuning</b>	A4 = 415.5 to 465.9 Hz (Initial Default: 440.0 Hz)
<b>Preset Scales</b>	17
<b>Music Preset</b>	305
<b>One Touch Preset</b>	180
<b>Auto Harmonize</b>	12 types
<b>Arpeggiator</b>	90 types
<b>MIDI</b>	16 multi-timbre received, GM Level 1 standard

<b>Musical Information Function</b>	Tone, Rhythm, Song Bank numbers and names, staff notation, fingering, pedal operation, tempo, measure and beat number, chord name, etc.
<b>Inputs/Outputs</b>	
<b>USB port</b>	TYPE B
<b>Sustain/Assignable jack</b>	Standard jack (sustain, sostenuto, soft, rhythm)
<b>Phones/Output jack</b>	Stereo standard jack Output Impedance: 140 $\Omega$ , Output Voltage: 4.5 V (RMS) MAX
<b>Audio In jack</b>	Stereo mini jack Input Impedance: 9 k $\Omega$ , Input Sensitivity: 200 mV
<b>Mic In/Sampling jack</b>	Standard jack (connect a dynamic microphone only) Input Impedance: 3 k $\Omega$ , Input Sensitivity: 10 mV
<b>Power Jack</b>	9.5 V DC
<b>Power Supply</b>	2-way
<b>Batteries</b>	6 D-size zinc-carbon batteries or alkaline batteries
<b>Battery Life</b>	Approximately 5 hours continuous operation on zinc-carbon batteries
<b>AC Adaptor</b>	AD-E95100L
<b>Auto Power Off</b>	Approximately 6 minutes (during battery operation) or 30 minutes (during AC adaptor operation) without any operation, Auto Power Off can be disabled.
<b>Speakers</b>	12cm $\times$ 2 (Output: 2.5W + 2.5W)
<b>Power Consumption</b>	9.5 V $\approx$ 7.7 W
<b>Dimensions</b>	116.1 $\times$ 38.5 $\times$ 13.4 cm (45 $\frac{3}{4}$ $\times$ 15 $\frac{3}{16}$ $\times$ 5 $\frac{1}{4}$ inch)
<b>Weight</b>	Approximately 6.9 kg (15.2 lbs) (without batteries)

\* This data is stored in a shared memory area with a total capacity of approximately 320 Kbytes (1 Kbyte = 1,024 bytes).

# BLOCK AND WIRING DIAGRAM

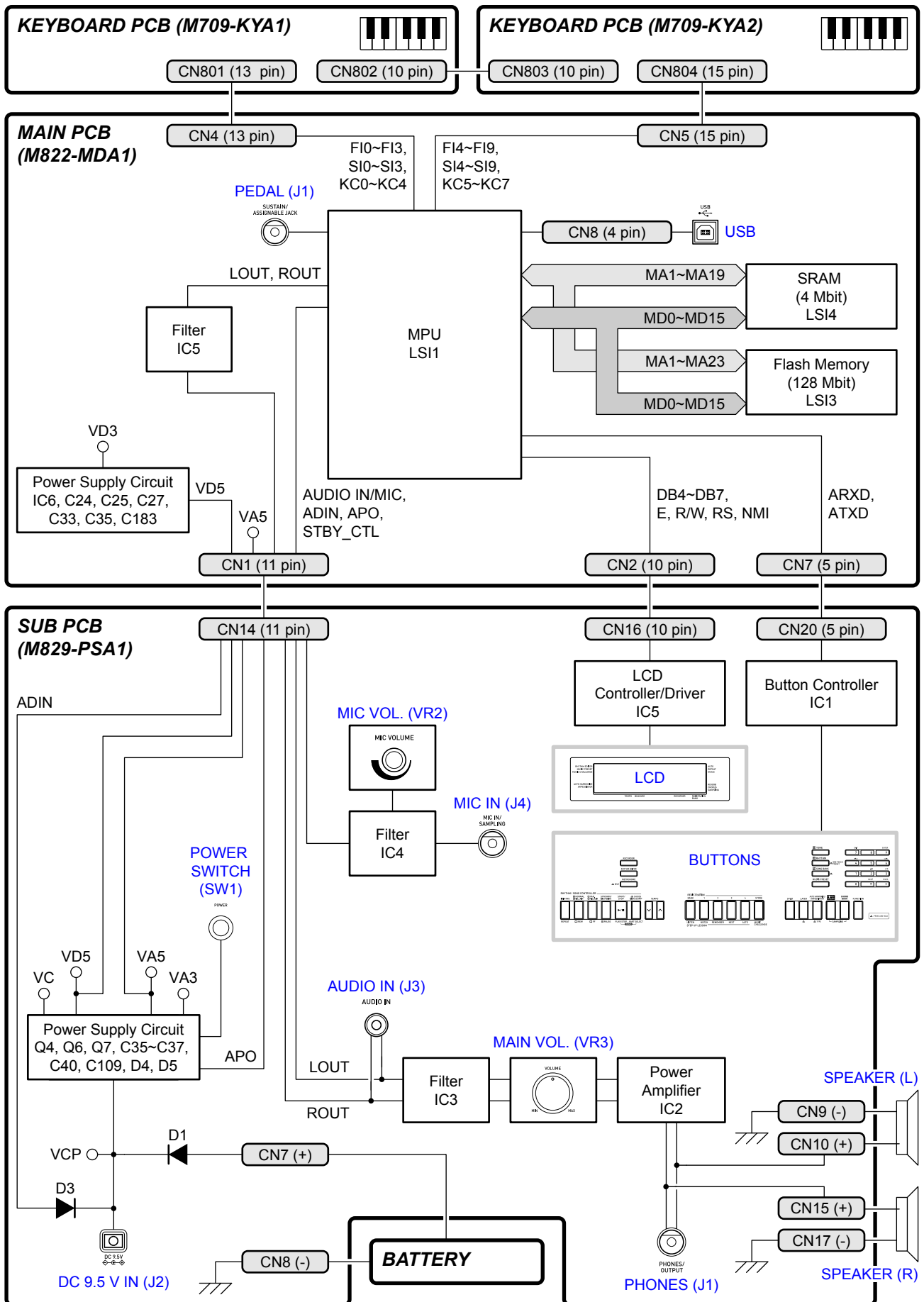

## PCB INFORMATION

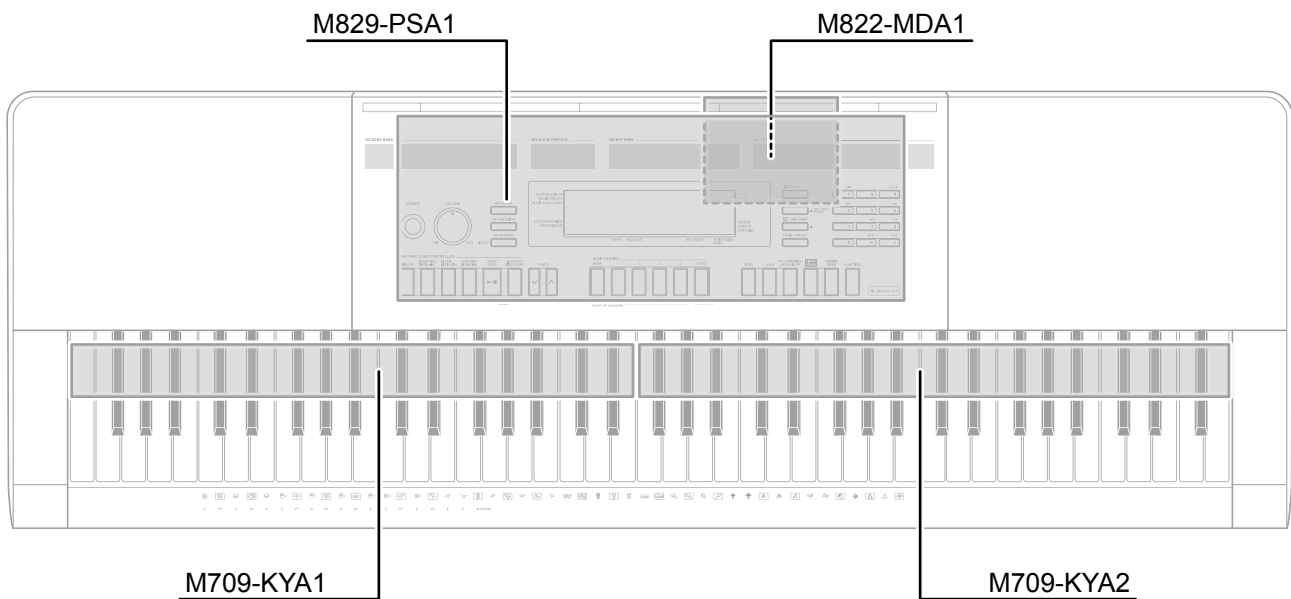

Classification	Parts Name	PCB Name	Components
Main PCB	PCB UNIT/MAIN	M822-MDA1	MPU, SRAM (4 Mbit), Flash Memory (128 Mbit), Power Supply Circuit, Filter, SUSTAIN/ASSIGNABLE Jack, USB Port
Sub PCB	BACK LIGHT UNIT	M829-PSA1	Power Supply Circuit, Power Amplifier, Filters, LCD Controller/Driver, Button Controller, LCD, Buttons, Power Switch, Main Volume, MIC Volume, DC 9.5 V Terminal, AUDIO IN Jack, PHONES/OUTPUT Jack, MIC IN/SAMPLING Jack
Keyboard PCB	PCB UNIT/KYA	M709-KYA1	Keyboard
		M709-KYA2	

# CIRCUIT DESCRIPTION

## ■ KEY MATRIX

	KC0	KC1	KC2	KC3	KC4	KC5	KC6	KC7
FI0		E1①	F1①	F1#①	G1①	G1#①	A1①	A1#①
SI0		E1②	F1②	F1#②	G1②	G1#②	A1②	A1#②
FI1	B1①	C2①	C2#①	D2①	D2#①	E2①	F2①	F2#①
SI1	B1②	C2②	C2#②	D2②	D2#②	E2②	F2②	F2#②
FI2	G2①	G2#①	A2①	A2#①	B2①	C3①	C3#①	D3①
SI2	G2②	G2#②	A2②	A2#②	B2②	C3②	C3#②	D3②
FI3	D3#①	E3①	F3①	F3#①	G3①	G3#①	A3①	A3#①
SI3	D3#②	E3②	F3②	F3#②	G3②	G3#②	A3②	A3#②
FI4	B3①	C4①	C4#①	D4①	D4#①	E4①	F4①	F4#①
SI4	B3②	C4②	C4#②	D4②	D4#②	E4②	F4②	F4#②
FI5	G4①	G4#①	A4①	A4#①	B4①	C5①	C5#①	D5①
SI5	G4②	G4#②	A4②	A4#②	B4②	C5②	C5#②	D5②
FI6	D5#①	E5①	F5①	F5#①	G5①	G5#①	A5①	A5#①
SI6	D5#②	E5②	F5②	F5#②	G5②	G5#②	A5②	A5#②
FI7	B5①	C6①	C6#①	D6①	D6#①	E6①	F6①	F6#①
SI7	B5②	C6②	C6#②	D6②	D6#②	E6②	F6②	F6#②
FI8	G6①	G6#①	A6①	A6#①	B6①	C7①	C7#①	D7①
SI8	G6②	G6#②	A6②	A6#②	B6②	C7②	C7#②	D7②
FI9	D7#①	E7①	F7①	F7#①	G7①			
SI9	D7#②	E7②	F7②	F7#②	G7②			

Each key has two contacts, the first contact ① and second contact ②.

**NOTE:** The diagram below illustrates how the contacts work.

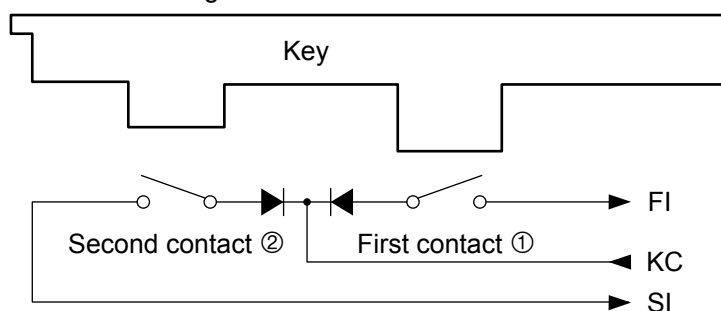

## ■ NOMENCLATURE OF KEYS

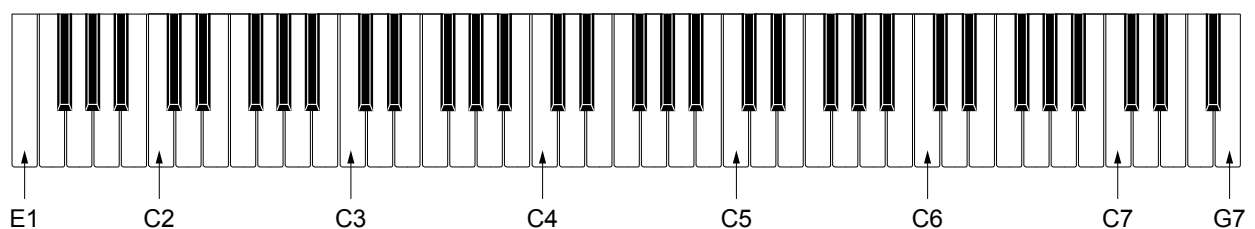

■ **BUTTON MATRIX**

	SWO0	SWO1	SWO2	SWO3	SWO4	SWO5	SWO6
SWI0	BANK, LISTEN	Area1, WATCH	RHYTHM, ↓ ONE TOUCH PRESET	MUSIC PRESET	4	8	9
SWI1	Area2, REMEMBER	Area3, NEXT	SONG BANK	TONE	7	5	6
SWI2	Area4, AUTO	STORE, MUSIC CHALLENGE			1	2	+
SWI3	↓ CHORDS, ACCOMP, PART SELECT	VAR./ FILL-IN, FF	TEMPO ↓	RECORDER	0	-	3
SWI4	NORMAL/ FILL-IN, REW	START/ STOP, PLAY/ STOP		TEMPO ^	SPLIT	CHORD BOOK	AUTO HARMONIZE/ ARPEGGIATOR, ↓ TYPE
SWI5	INTRO, REPEAT	SYNCHRO/ ENDING, PAUSE	METRONOME, ↓ BEAT	RHYTHM EDITOR	LAYER	PIANO/ ORGAN	FUNCTION



# PRINTED CIRCUIT BOARDS

Main PCB: M822-MDA1

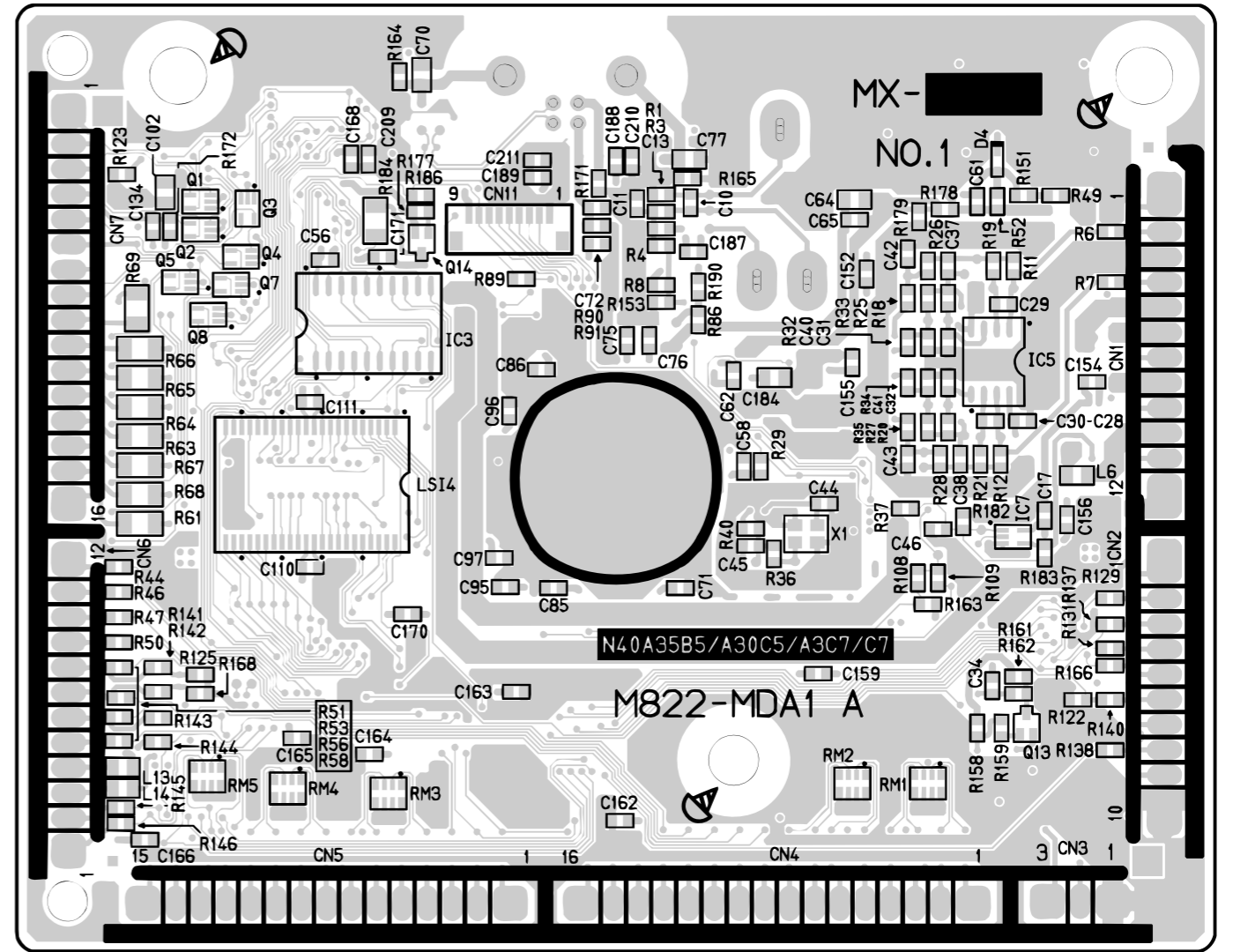
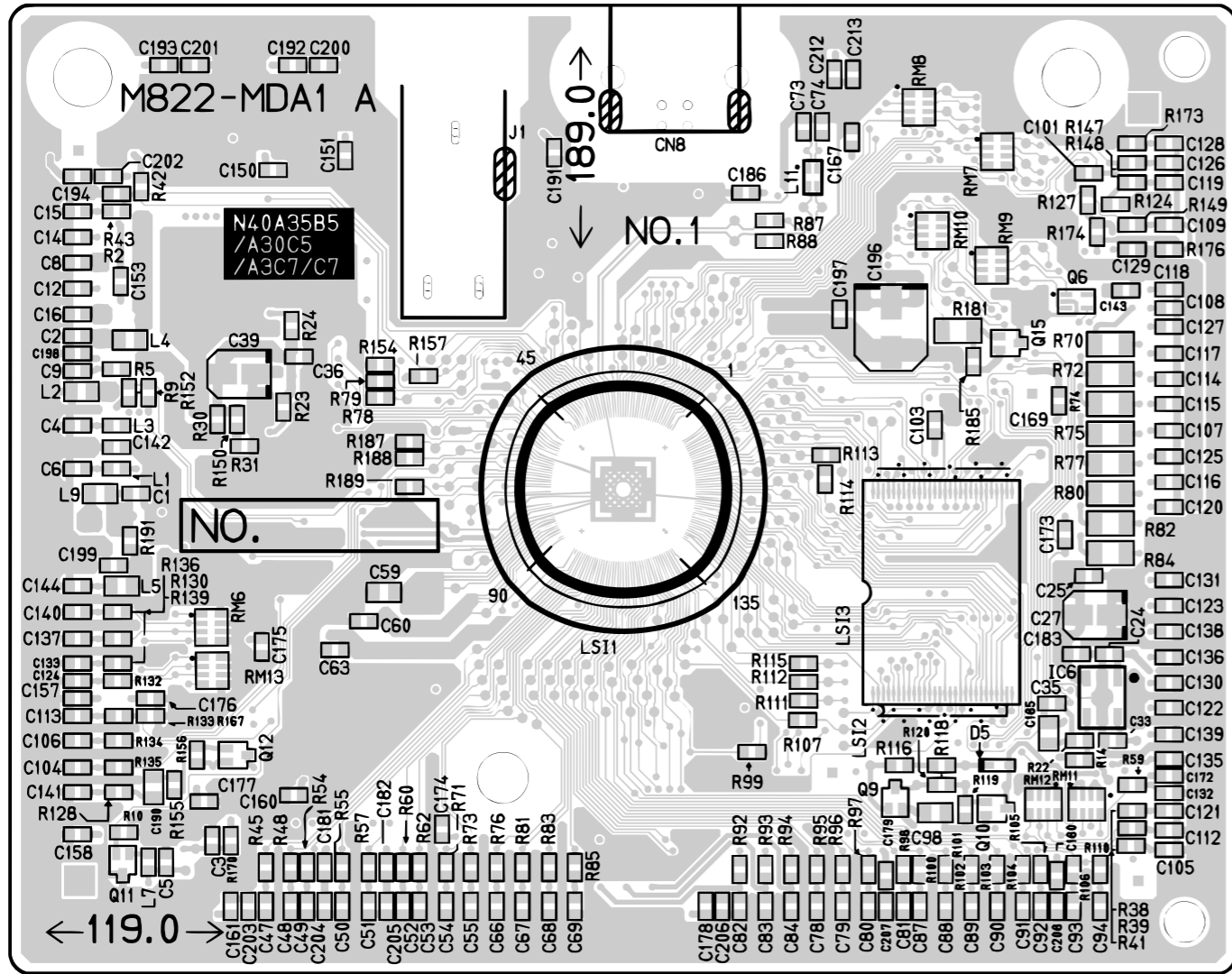

Sub PCB: M829-PSA1

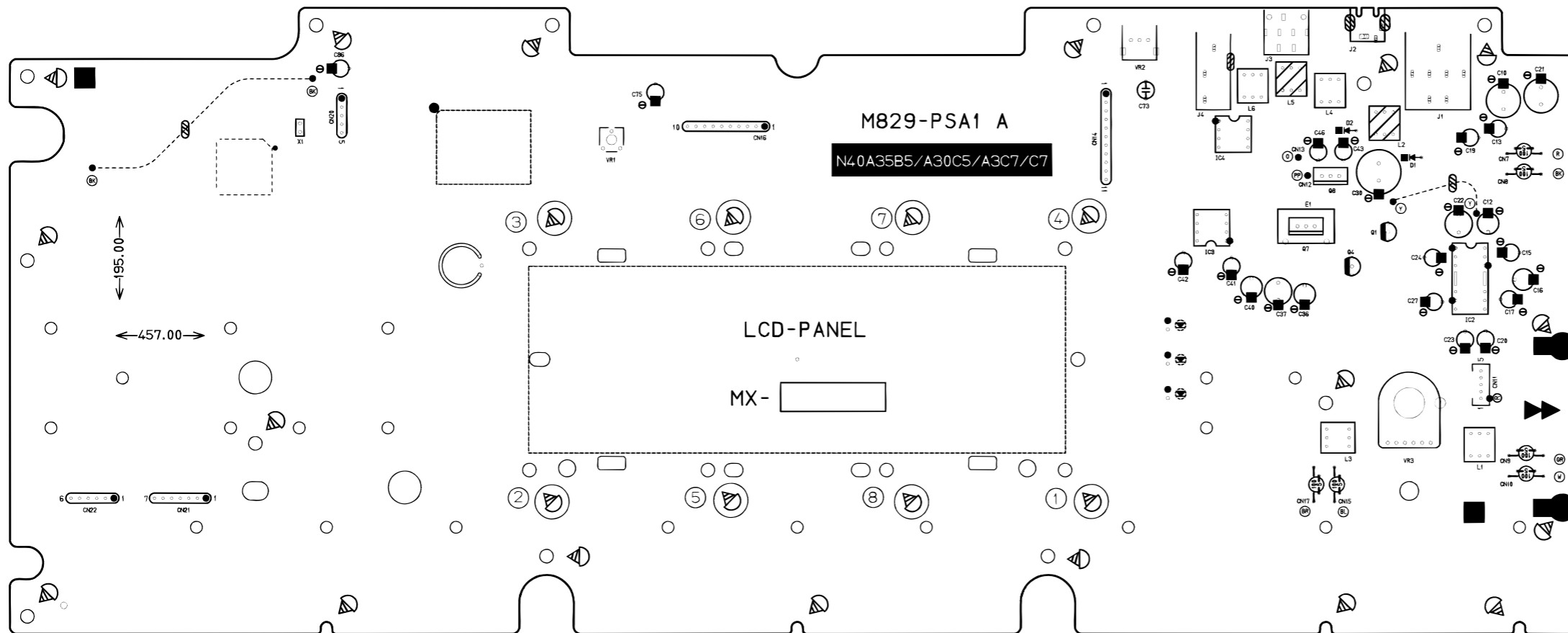
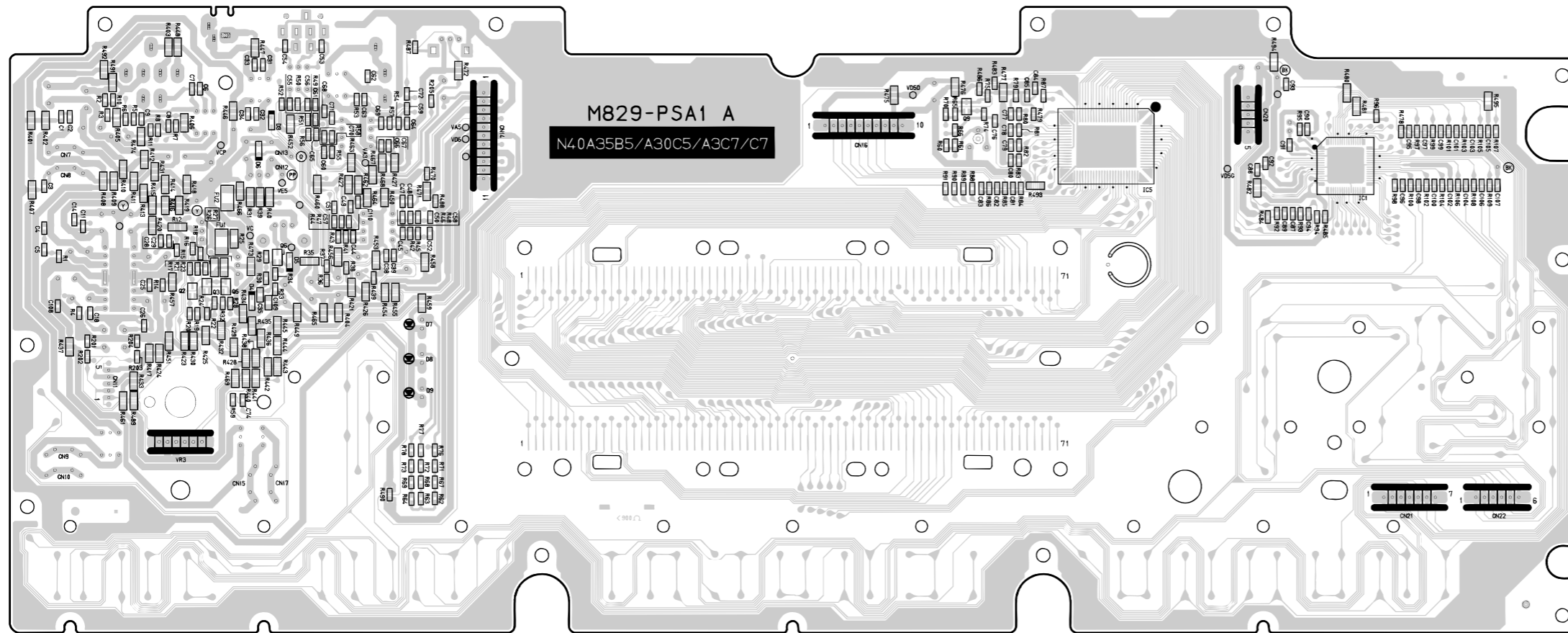



## DISASSEMBLY

### ■ CAUTION

- The photos show a prototype. The appearance of the instrument, such as color, may differ from the actual model.
- To avoid damages to the instrument and the floor, lay the instrument on a mattress or blanket before starting disassembling.
- There are several kinds of screws. Be sure to use the correct type of screws when reassembling. It is advisable to sort the screws as shown below after removing them.

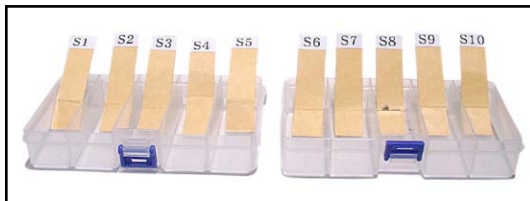

- If a screw cap is attached to a screw, be sure to reattach the screw cap when reassembling.

### ■ BEFORE STARTING REPAIR OR SERVICING

- Remove the AC adaptor, AC cord or batteries.
- Remove accessories such as the music stand.

## ■ DISASSEMBLY

### A. REMOVE THE PANEL UNITS

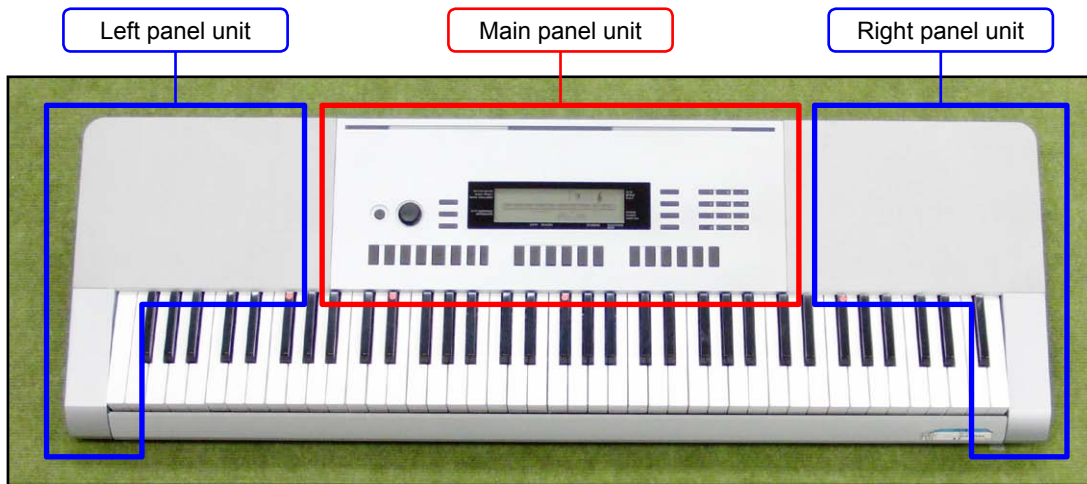

A-1. Undo 21 or seven screws on the bottom surface of the main unit.

**NOTE:** To remove only the main panel unit, undo seven screws indicated with red circles in the illustration below.

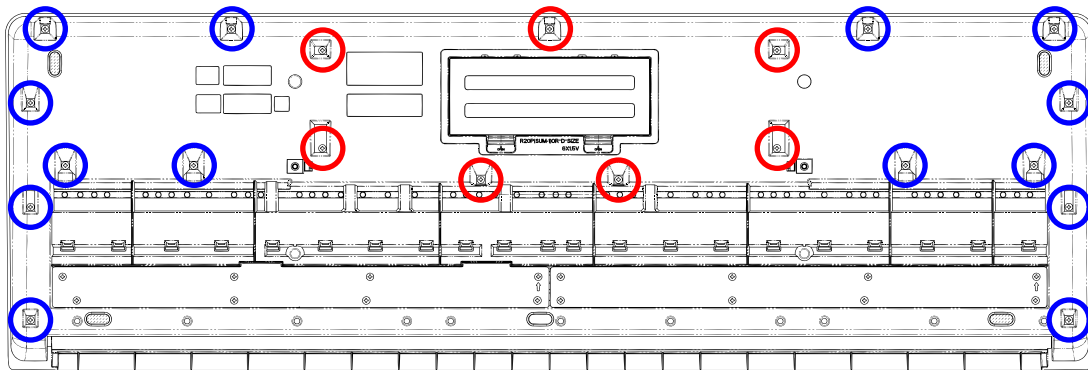

A-2. Place the main unit with the keys facing up.

A-3. Lift the main panel unit and turn it over.

**NOTE:** The main panel unit is connected to the lower case unit with the lead wires and FFCs. Use caution when turn over the main panel unit.

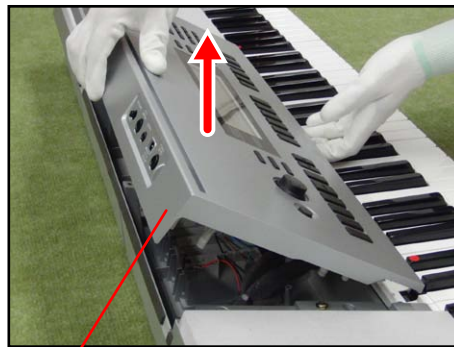

Main panel unit

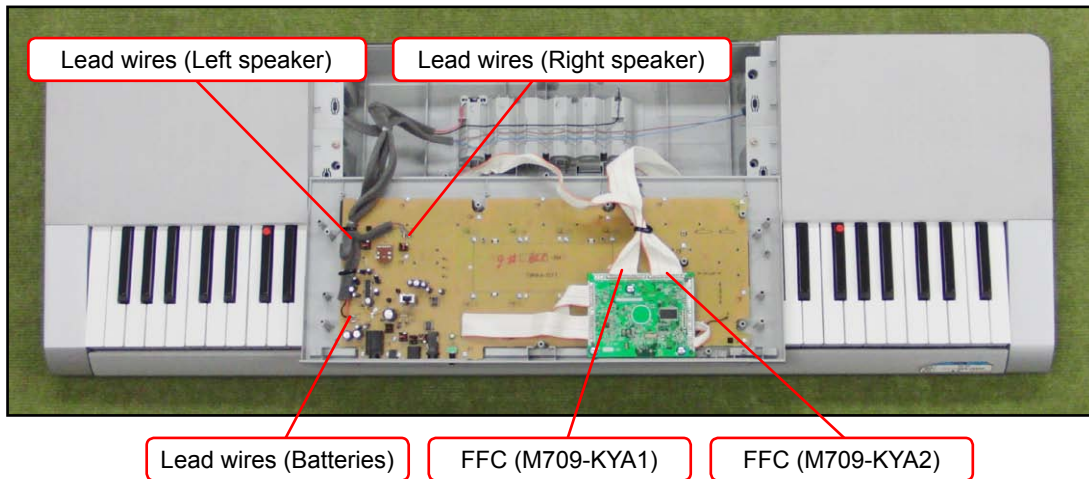
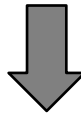

A-4. Unsolder six lead wires and two FFCs.

A-5. Remove the main panel unit.

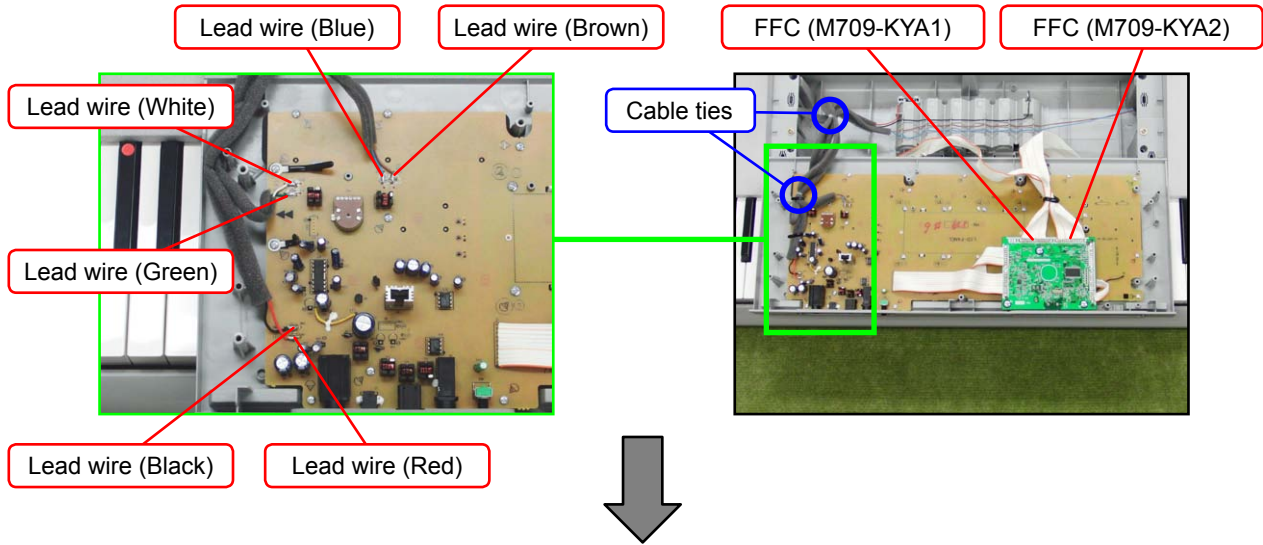

**<Notes On Assembly>**

- The number of pins on the PCB pad differs from that on the cable. Solder in the way that No.1 pin on the cable (orange) is connected to No.1 pad on the PCB.

FFC (M709-KYA1)  
 PCB: 16 pads  
 Cable: 13 pins

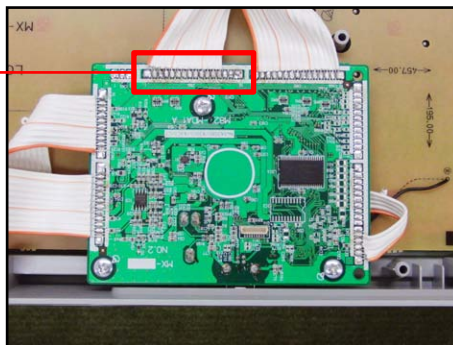

A-6. Undo one screw and then remove the right panel unit.

A-7. Undo one screw and then remove the left panel unit.

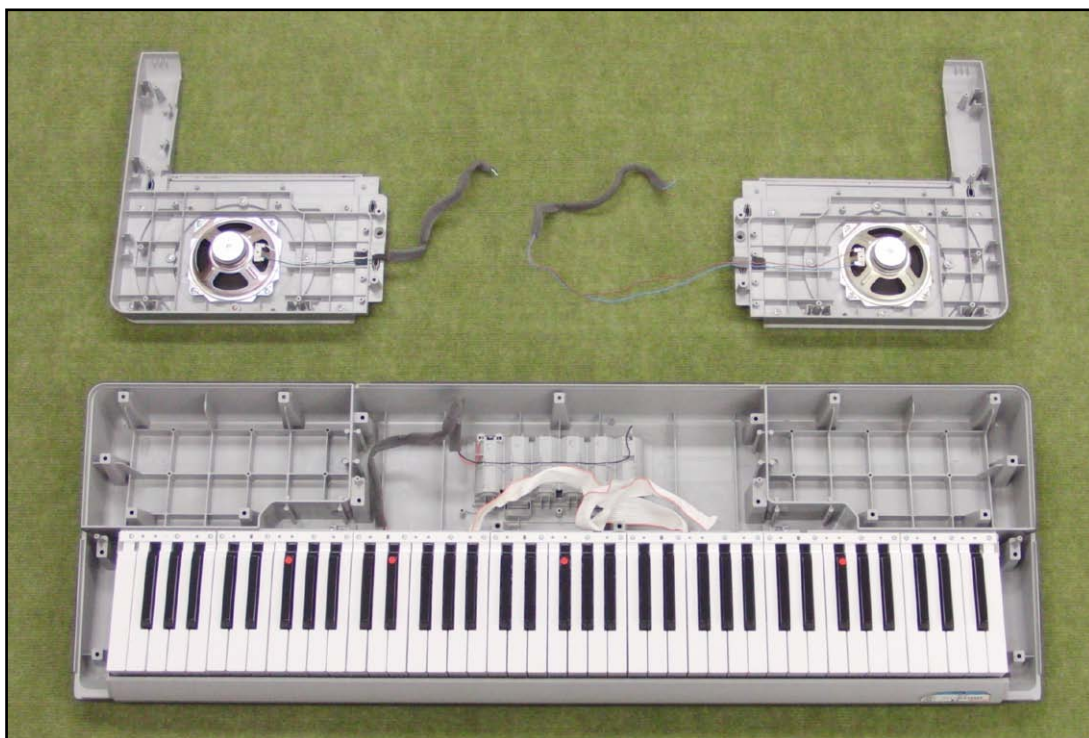
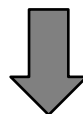
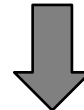
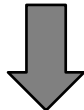
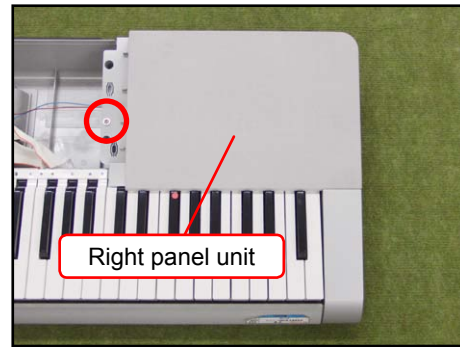
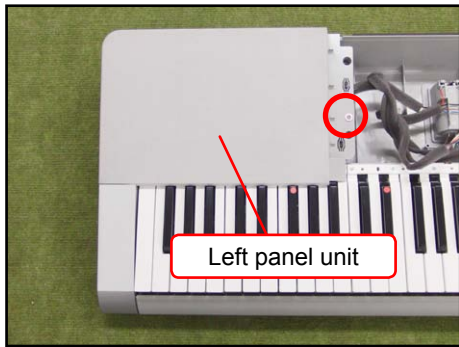



## B. REMOVE THE M822-MDA1 PCB (MAIN PCB)

B-1. Unsolder three FFCs.

B-2. Undo three screws and then remove the M822-MDA1 PCB.

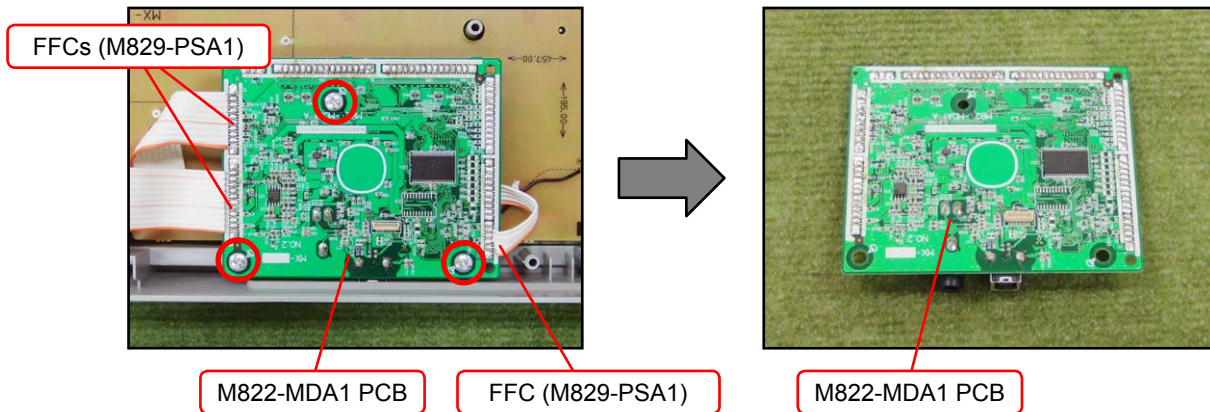

### <Notes On Assembly>

- The number of pins on the PCB pad differs from that on the cable. Solder in the way that No.1 pin on the cable (orange) is connected to No.1 pad on the PCB.

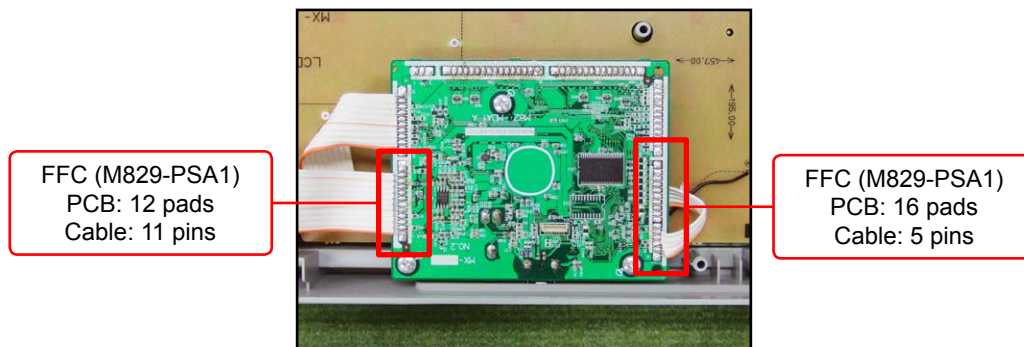

## C. REMOVE THE BACK-LIGHT-UNIT

C-1. Remove the ROTARY-KNOB.

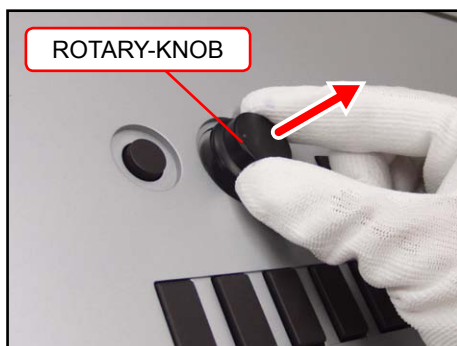

- C-2. Undo 27 screws and then remove the BACK-LIGHT-UNIT, LCD components and rubber keys.  
**NOTE:** There are three types of screws. Be sure to use the correct screw when reassembling.

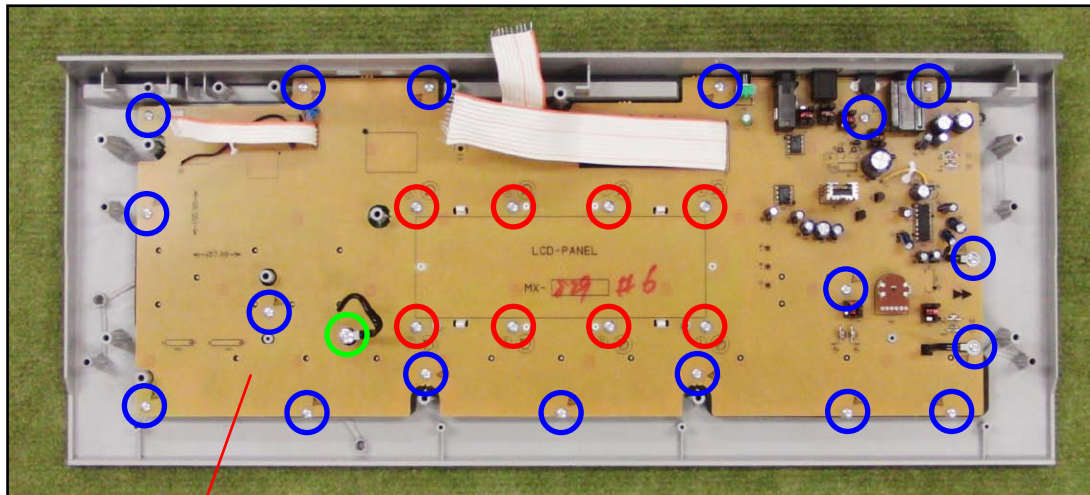

BACK-LIGHT-UNIT

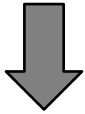

BACK-LIGHT-UNIT

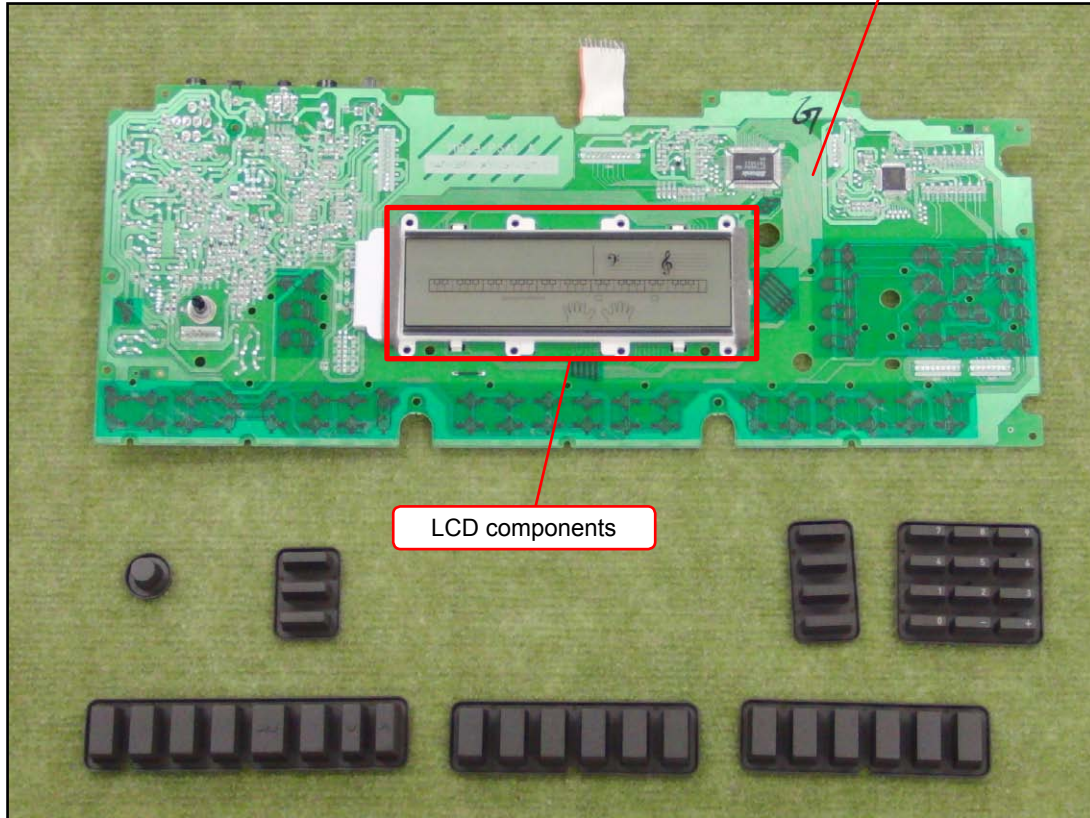

LCD components

**<Notes On Assembly>**

- To install the M829-PSA1 PCB of BACK-LIGHT-UNIT, tighten the screws for the LCD part in the order indicated with the numbers below. If not tighten correctly, it may cause the LCD display errors.

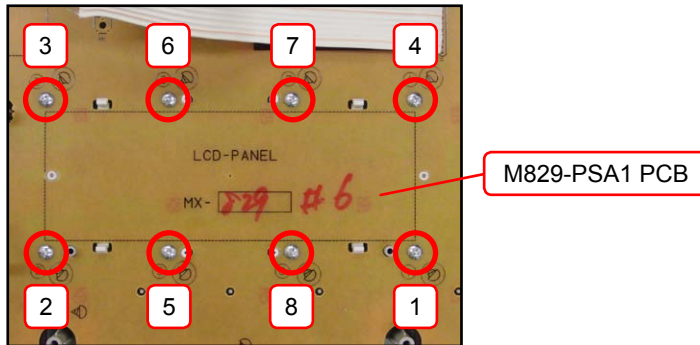

**D. REMOVE THE SPEAKER**

- D-1. Unsolder two lead wires.
- D-2. Undo four screws and then remove the SPEAKER.

**<Left speaker>**

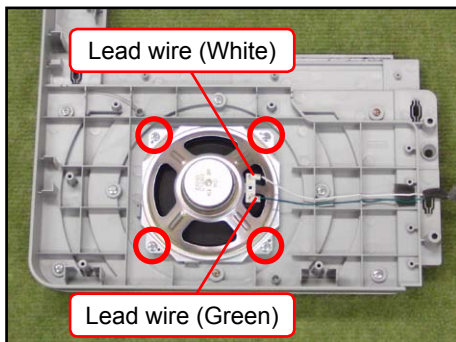

**<Right speaker>**

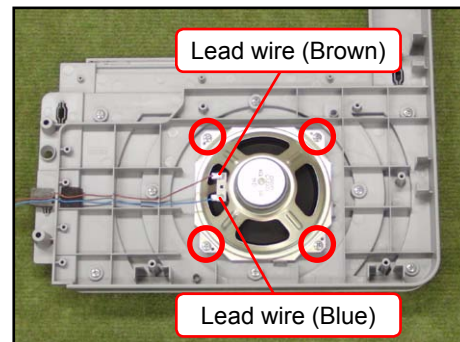

## E. REMOVE THE KEYBOARD

E-1. Undo 26 screws and then remove the keys.

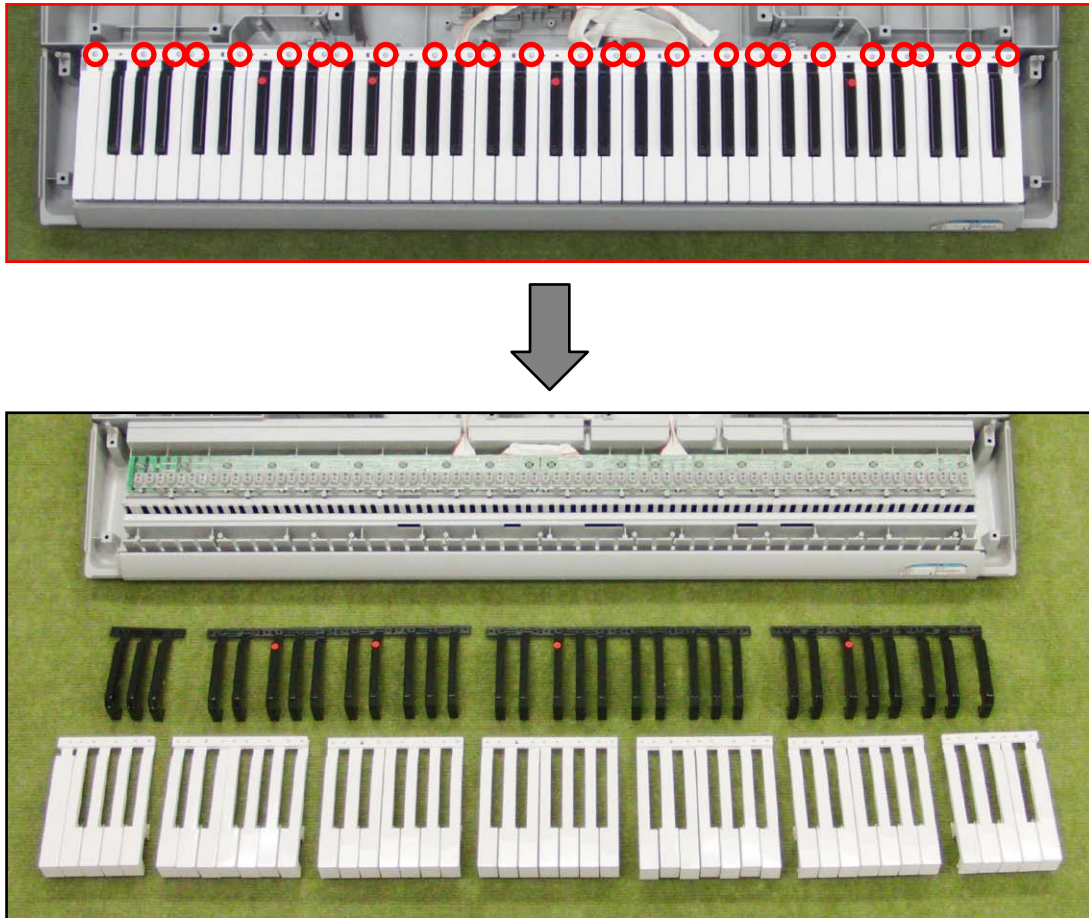

## F. REMOVE THE M709-KYA1/KYA2 PCBs (KEYBOARD PCB)

F-1. Disengage the hooks and then remove the M709-KYA1/KYA2 PCBs.

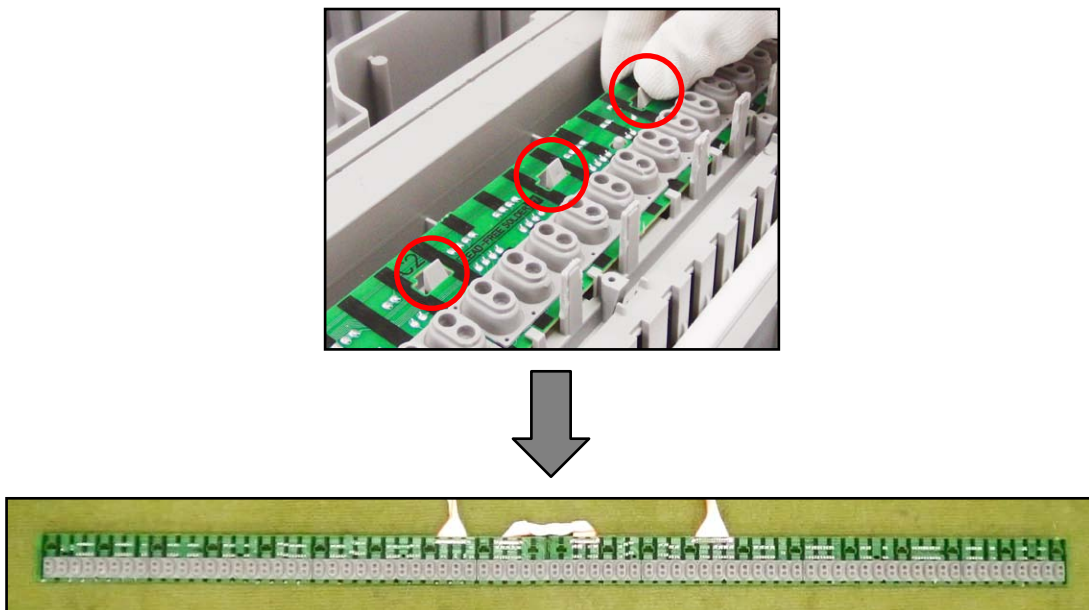

F-2. Remove seven rubber contact strips.

**NOTE:** There are three types of rubber contact strips with differing lengths.

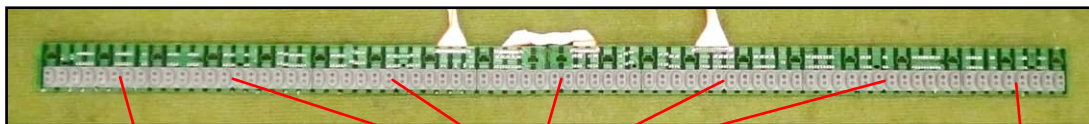



Rubber contact strips 1

Rubber contact strips 2

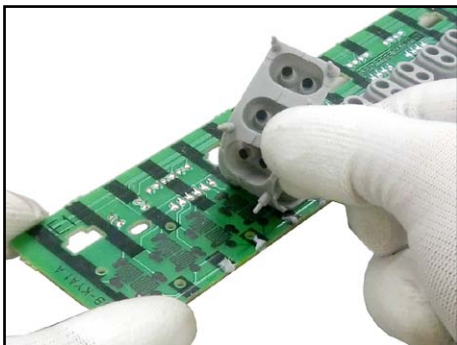
Rubber contact strips 3



<p><b>Rubber contact strips 1</b> (Length: 106.15 mm)</p>	
<p><b>Rubber contact strips 2</b> (Length: 162.10 mm)</p>	
<p><b>Rubber contact strips 3</b> (Length: 109.10 mm)</p>	

**<How To Install Rubber Contact Strips>**

- Lightly insert the tip of a rubber contact strip into the PCB. Pull the tip from the back of the PCB and install it using a tool such as tweezers. Do not forcibly pull it.

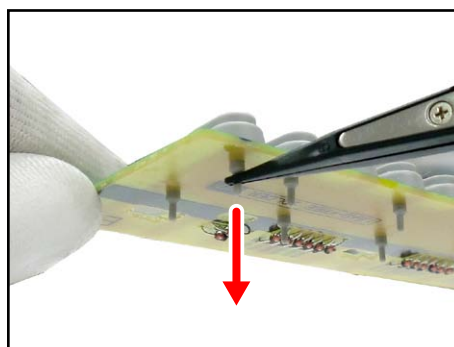

# DIAGNOSTIC PROGRAM

## ■ PREPARATION

- (1) Connect the AC adaptor.

**NOTE:** The AC adaptor (AD-E95100L) for the WK-220\_DI and WK-220\_UK is sold separately and does not come with the product. If you do not have the AC adaptor, use six D-size dry batteries with enough capacity.

**NOTE:** “AC ADAPTOR CHECK” cannot be performed unless the AC adaptor is connected.

- (2) Turn the main volume to the maximum.
- (3) Turn the MIC volume to the maximum.
- (4) Connect the pedal (SP-3 or SP-20) to the SUSTAIN/ASSIGNABLE jack.

**NOTE:** SP-3 and SP-20 pedals are sold separately.  
“PEDAL CHECK” cannot be performed unless the pedal is connected.

- (5) Have a PC and a USB cable ready.

**NOTE:** “USB CHECK” cannot be performed without a PC and a USB cable.

Operating System: Windows® XP (SP2 or later) \*1  
Windows Vista® \*2  
Windows 7® \*3  
Mac OS® X (10.3.9, 10.4.11, 10.5.8 or later, 10.6.6 or later)

\*1: Windows XP Home Edition/Windows XP Professional (32 bit)

\*2: Windows Vista (32 bit)

\*3: Windows 7 (32 bit, 64 bit)

## ■ HOW TO START THE DIAGNOSTIC PROGRAM

- (1) Hold down the “0”, “1” and “2” buttons at the same time, to turn the power ON.

**NOTE:** Be sure to turn OFF the power when the test is finished.

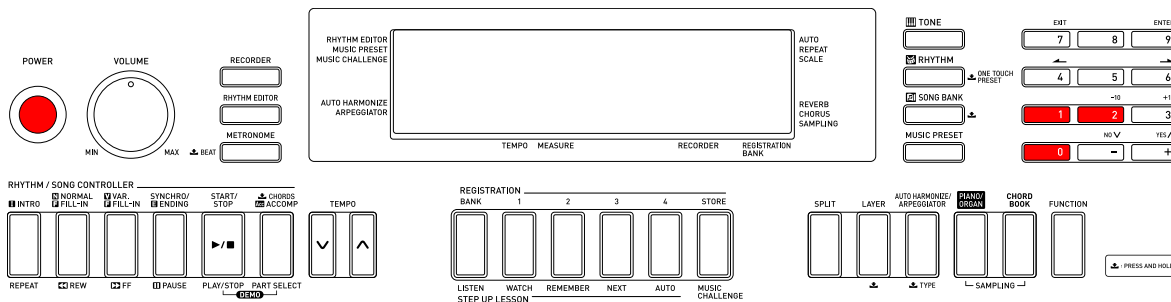

- (2) Release the “0”, “1” and “2” buttons.
- (3) After the diagnostic program is launched, the test mode screen appears.

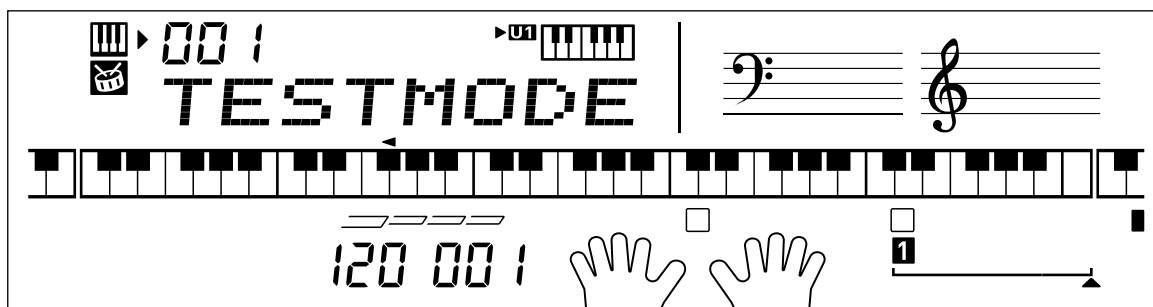

## ■ TEST ITEMS

Pressing a test button after the diagnostic program was launched or while on the main screen enables the corresponding test item to be tested.

Test Items	Buttons	Note
A. BUTTON CHECK	1	
B. AC ADAPTOR CHECK	3	AC apaptor
C. ROM CHECK	5	
D. RAM CHECK	6	
E. ROM VERSION & MODEL CHECK	9	
F. LCD CHECK	2	
G. PEDAL CHECK	RHYTHM	Pedal (SP-3 or SP-20)
H. USB CHECK		PC, USB cable

<Test Mode Main Screen>

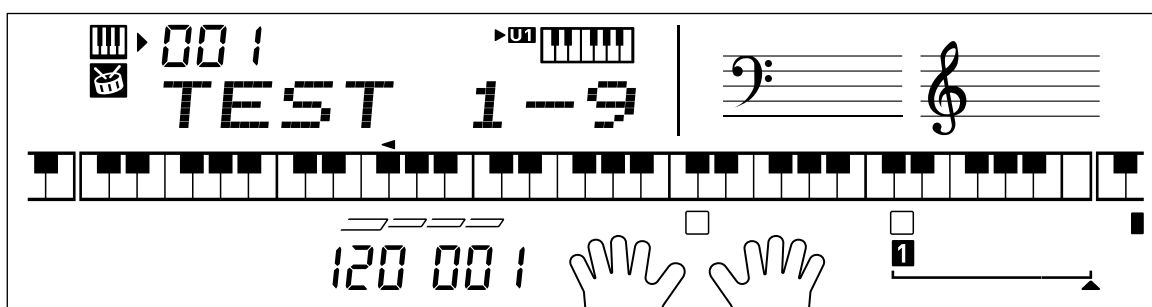

## ■ TEST PROCEDURES

### A. BUTTON CHECK

A-1. Press the "1" button to select the "BUTTON CHECK".

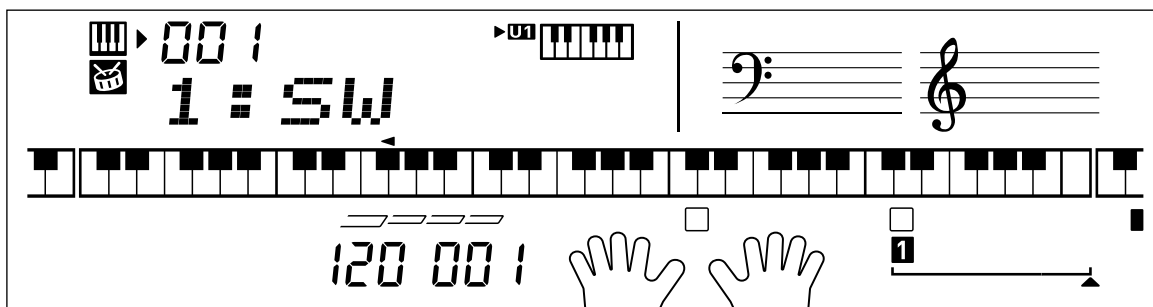

A-2. Press the button in the order indicated in the illustration.

**NOTE:** You cannot cancel this check procedure mid-way.

**<If the result passes>**

The confirmation chord sounds and “1:SW00XX” is displayed on the LCD with “XX” indicating the corresponding button number in the illustration.

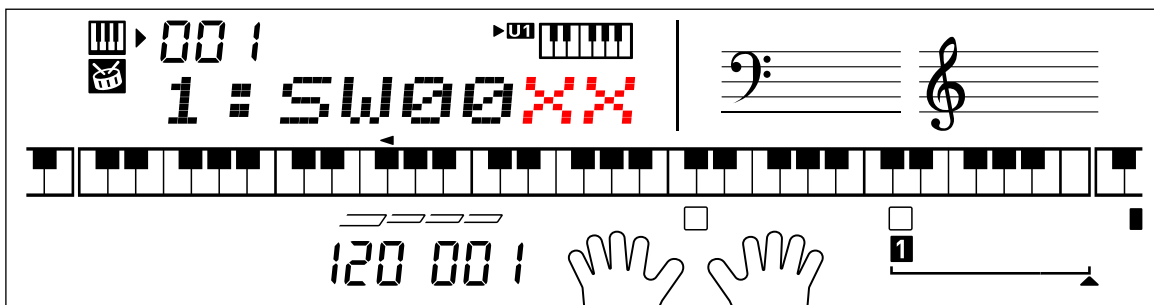

**<If the result fails>**

If there is a button failure or the buttons are pressed in a wrong sequence, an error tone sounds and the button number which you pressed will be displayed on the LCD.

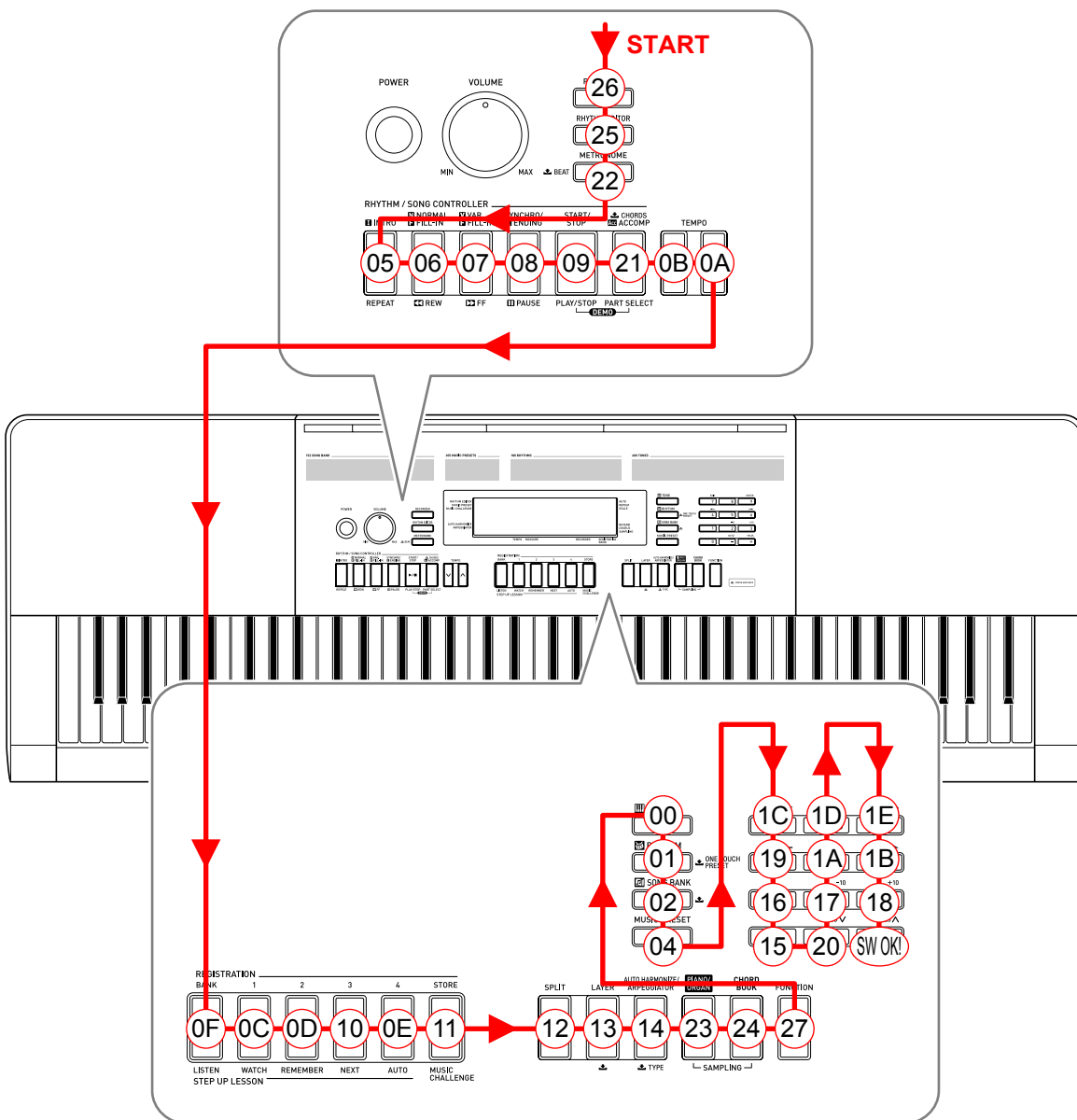



- A-3. When the “+” button is pressed at the end, a confirmation chord sounds and “1:SW OK!” is displayed on the LCD.
- A-4. Check to see if the LCD is as shown below.

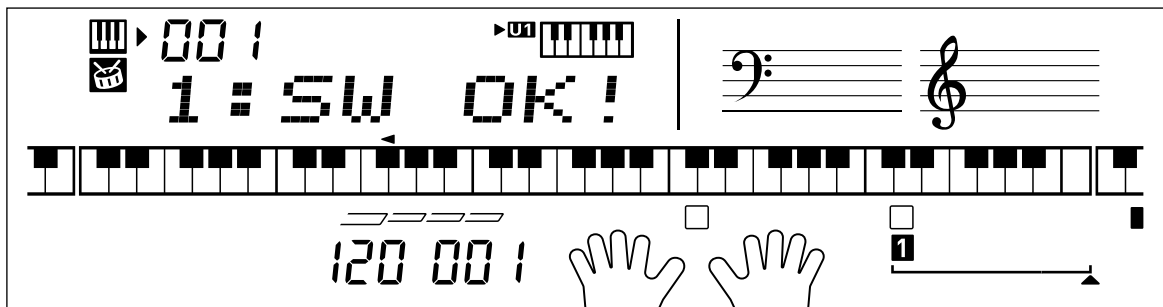

- A-5. Press the “0” button to return to the main screen.

## B. AC ADAPTOR CHECK

- B-1. Press the “3” button to select the “AC ADAPTOR CHECK”.
- B-2. Make sure that a value “XXX” shown in the illustration is in the range of 000 to 3FF.

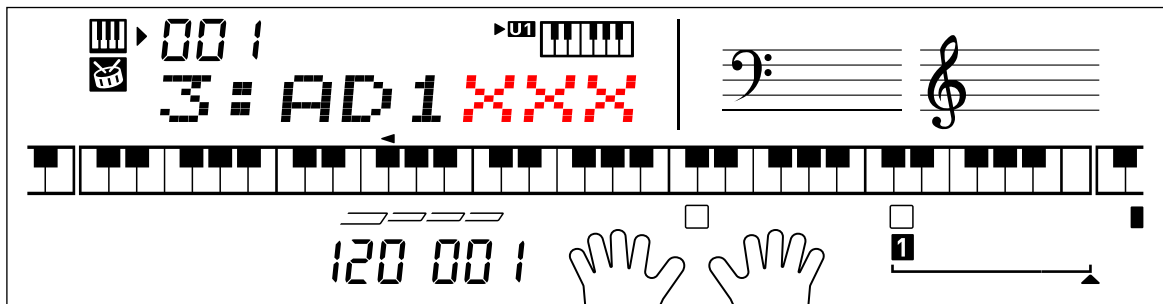

- B-3. Press the “3” button again.
- B-4. Make sure that a value “XXX” shown in the illustration is in the range of 000 to 1FF.

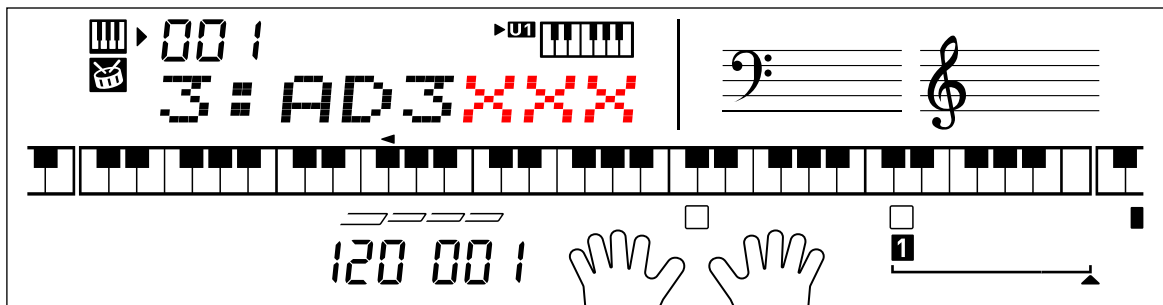

- B-5. Press the “0” button to return to the main screen.

### C. ROM CHECK

C-1. Press the "5" button to select the "ROM CHECK".

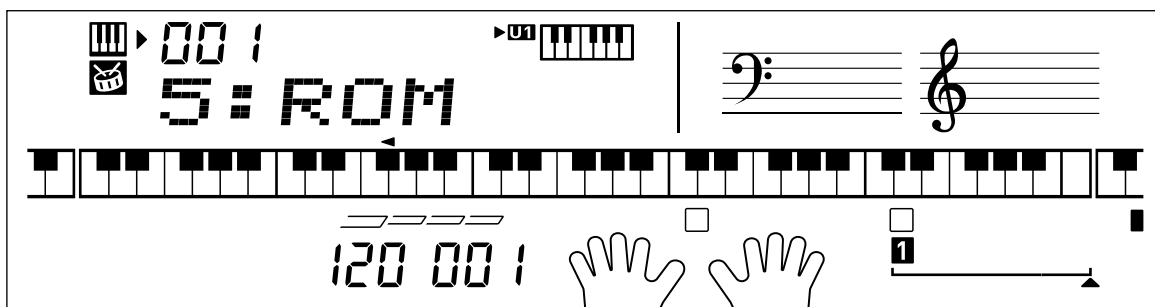

C-2. Press the "1" button to perform the check.

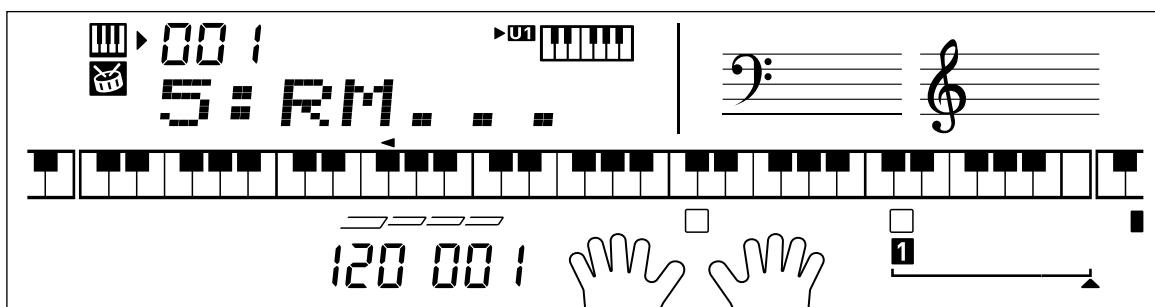

C-3. Check to see if the LCD is as shown below.

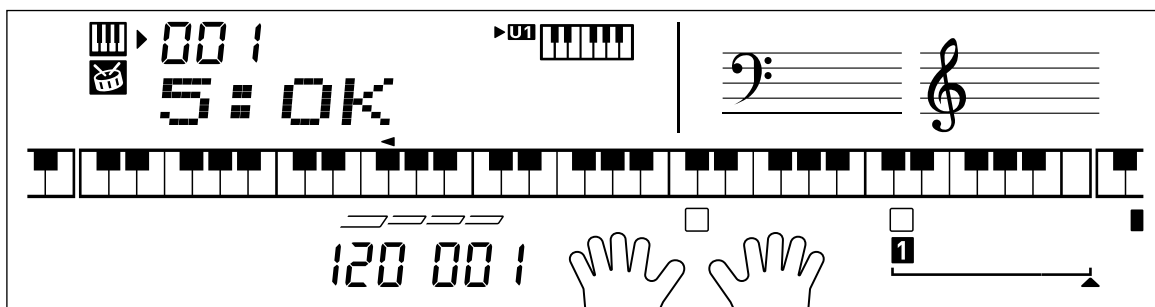

C-4. Press the "0" button to return to the main screen.

## D. RAM CHECK

D-1. Press the “6” button to select the “RAM CHECK”.

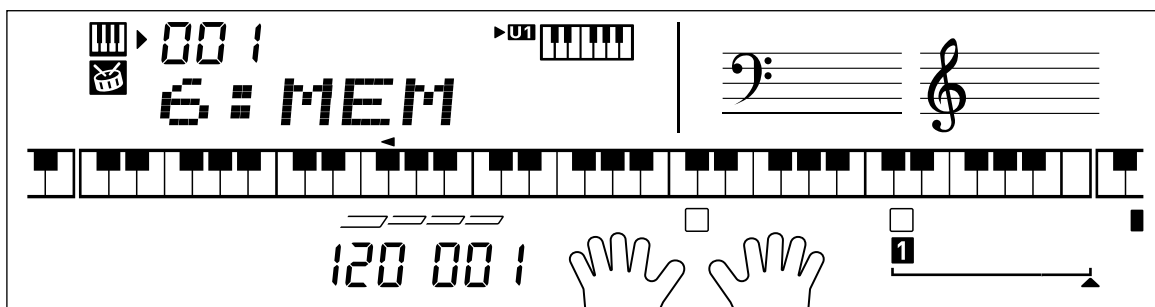

D-2. Press the “1” button to perform the check.

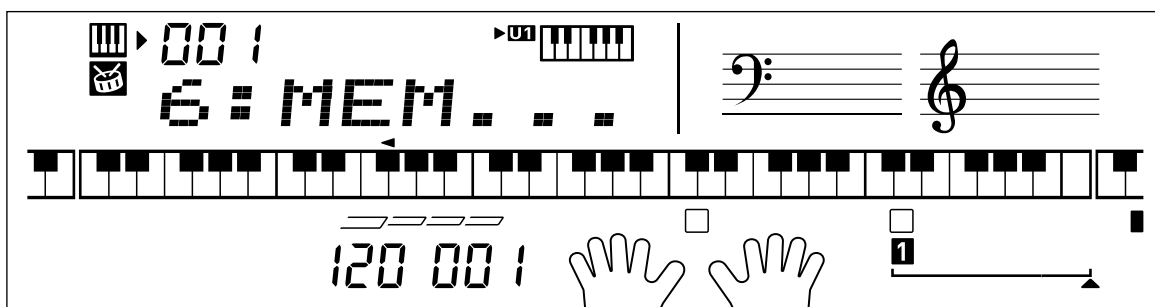

D-3. Check to see if the LCD is as shown below.

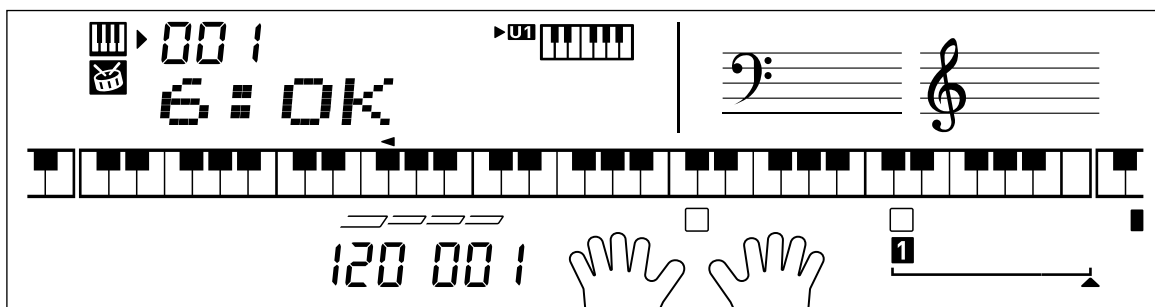

D-4. Press the “0” button to return to the main screen.

## E. ROM VERSION & MODEL CHECK

- E-1. Press the “9” button to perform the “ROM VERSION CHECK”.  
The ROM version appears on the LCD.
- E-2. Check that the ROM version is “18369”.

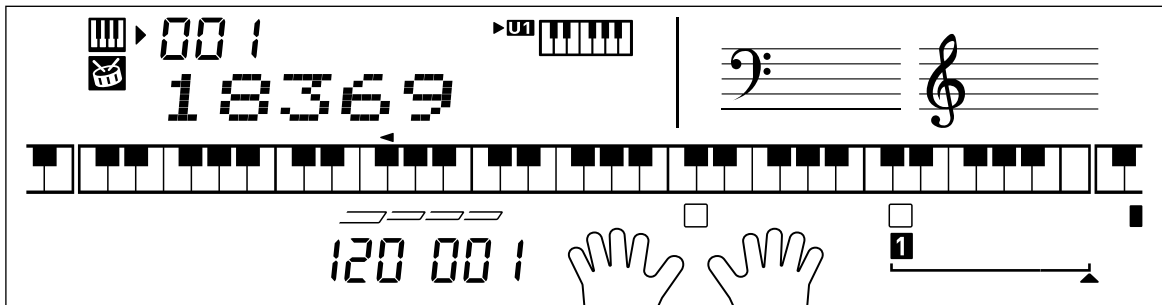

- E-3. Press the “9” button to perform the “MODEL CHECK”.  
The model name appears on the LCD.
- E-4. Check that the model name is “MX829”.

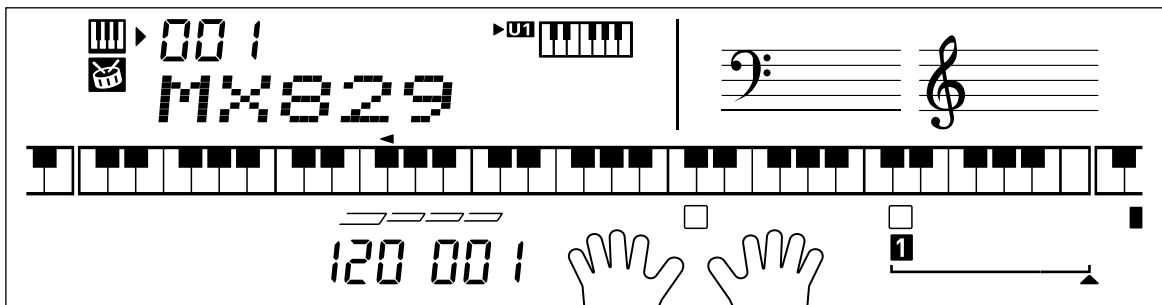

- E-5. Press the “0” button to return to the main screen.

## F. LCD CHECK

F-1. Press the “2” button to select the “LCD CHECK”.

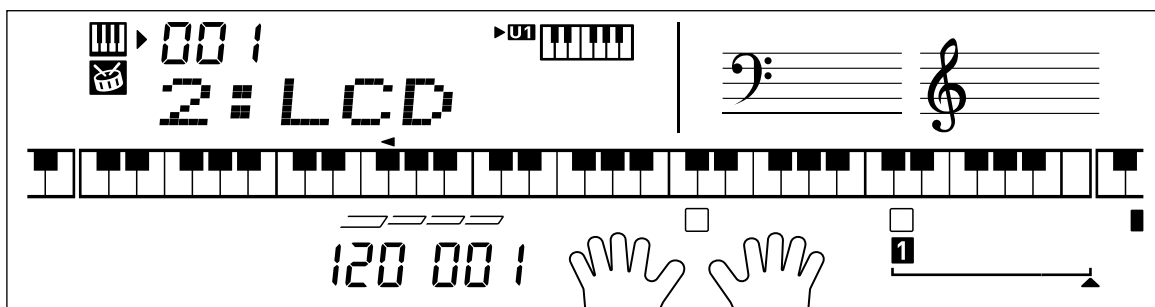

F-2. Press the “2” button and check to see if all LCDs are lit.

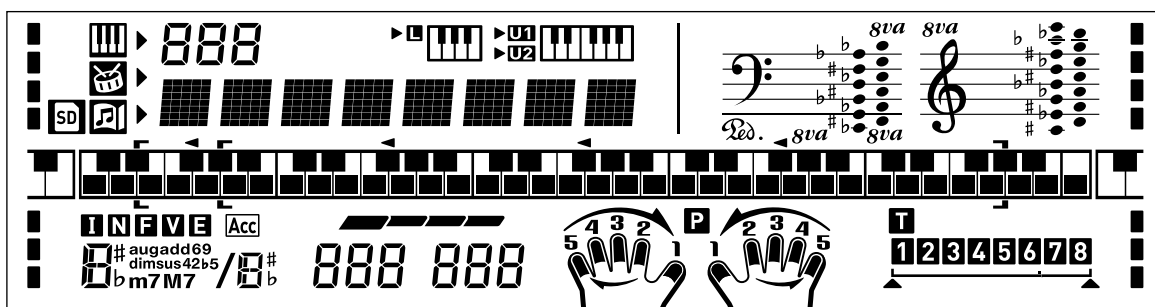

F-3. Press the “2” button and check to see if all LCDs are turned off.

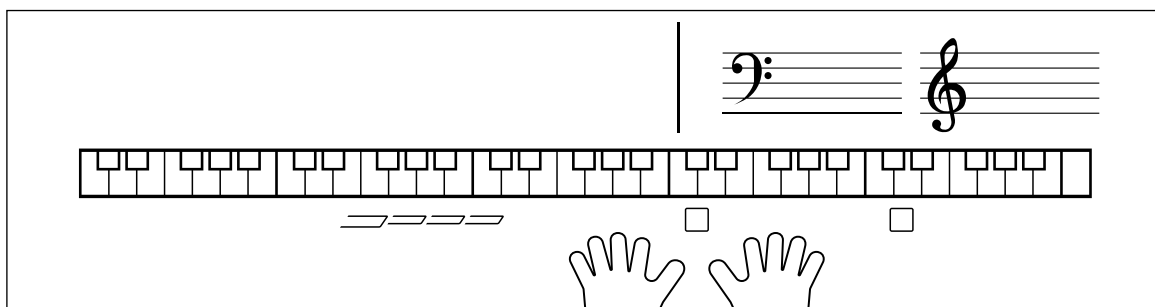

F-4. Press the “0” button to return to the main screen.

## G. PEDAL CHECK

G-1. Press the “RHYTHM” button to select the “PEDAL CHECK”.

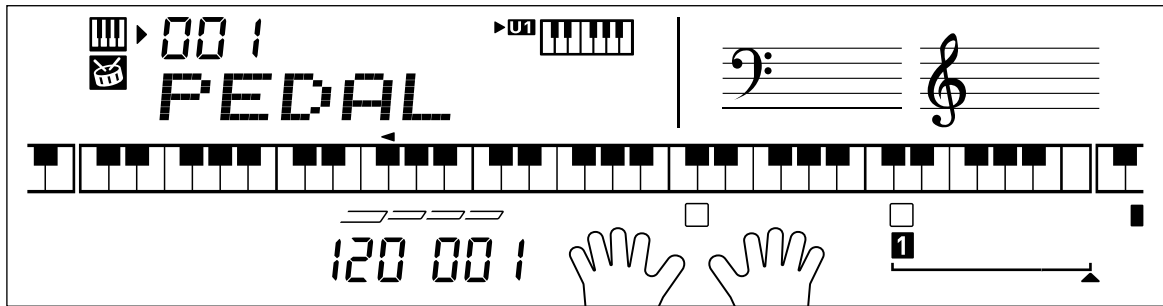

G-2. Press the pedal.

G-3. Check to see if the LCD is as shown below.

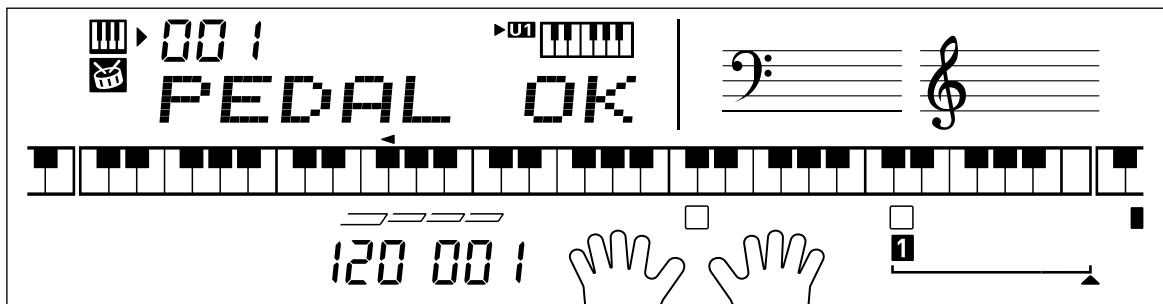

G-4. Press the “0” button to return to the main screen.

## H. USB CHECK

**NOTE:** The following procedures are for a PC with Windows XP.

- H-1. Connect the main unit to the PC with a USB cable.
- H-2. Open the windows “Device Manager”, and then make sure “USB Audio Devices” is listed under “Sound, video and game controllers”.
- H-3. Disconnect the USB cable.
- H-4. Verify “USB Audio Devices” is not listed under “Sound, video and game controllers”.

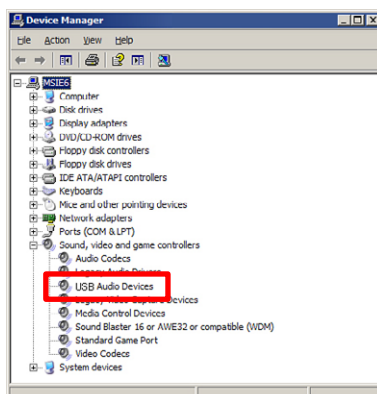

# EXPLODED VIEW

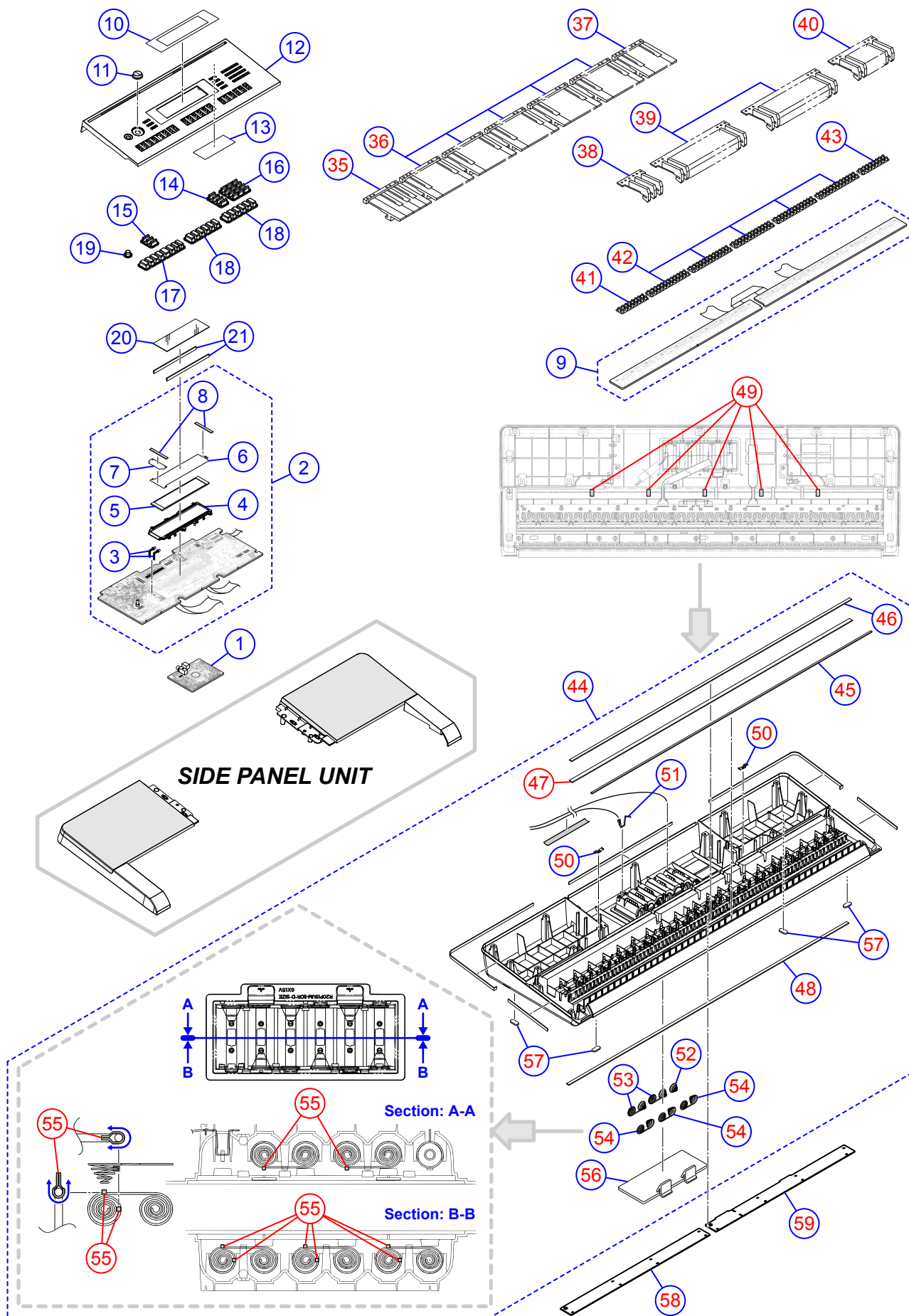

**SIDE PANEL UNIT**

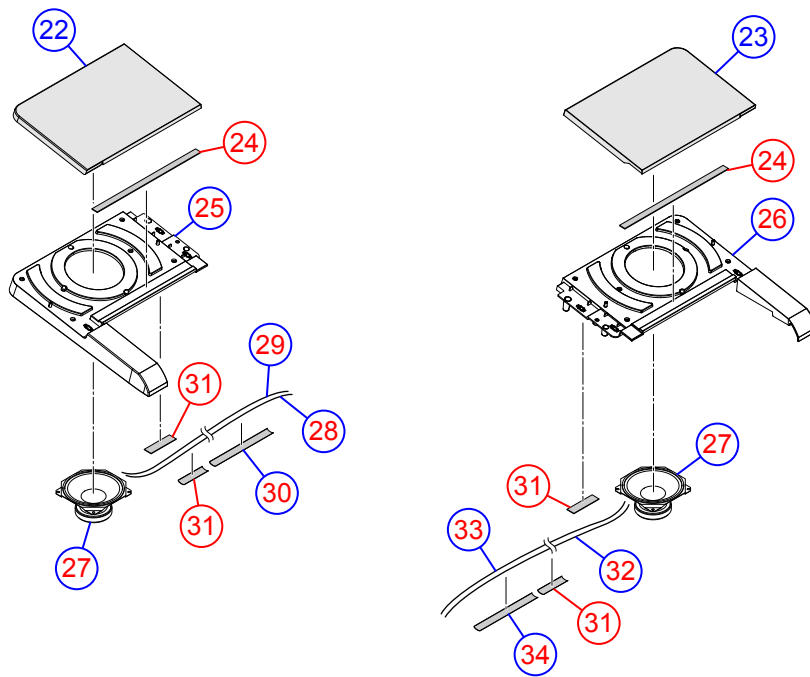

**LEFT SIDE**

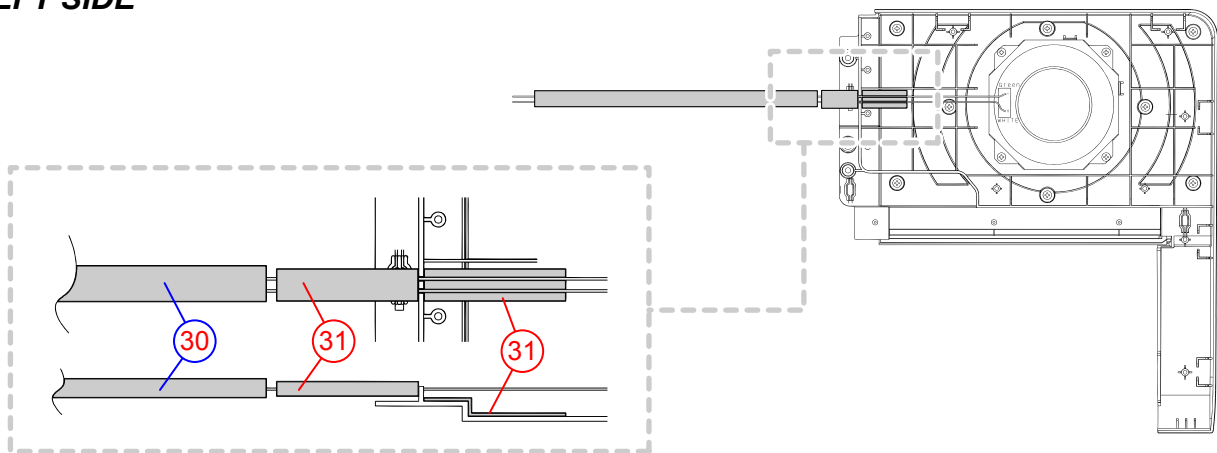

**RIGHT SIDE**

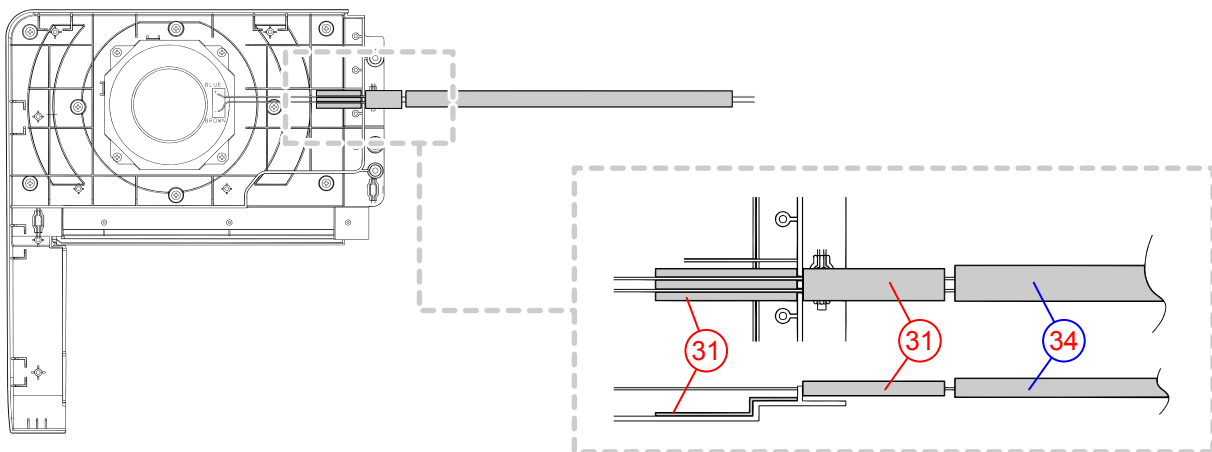



# PARTS LIST

## WK-220

Notes:

1. Prices and specifications are subject to change without prior notice.
2. Refer to the latest "Parts Price Code" at "PARTS FINDER" on the Casio Service WEB site (<https://www.servicecasio.com>).
3. As for spare parts order and supply, refer to the "GUIDEBOOK for Spare parts Supply", published separately.
4. The numbers in item column correspond to the same numbers in drawing.

- 1: WK-220\_DI  
 2: WK-220\_EU  
 3: WK-220\_UK  
 4: WK-220\_US

N	Item	Code No.	Parts Name	Specification	Q'ty				Price Code	R	Remarks
					1	2	3	4			
<b>MAIN PCB</b>											
N	1	10399948	PCB UNIT/MAIN	TK-RJM511270*001	1	1	1	1		A	MDA1
	CN8	10236624	CONNECTOR/USB	UBR24-4K5G00	1	1	1	1		B	
	J1	10206815	JACK/SUSTAIN	JY-6314*01-030	1	1	1	1		B	
	D4	10009218	DIODE	1SS400TE61	1	1	1	1		X	
	IC5	10211950	IC	NJM2068M-D(TE1)	1	1	1	1		X	
N	IC6	10398240	IC	XC6402FV36PR-G	1	1	1	1		X	
	L11	10193074	COIL	DLW21HN181SQ2L	1	1	1	1		X	
	LSI4	10256784	LSI/MEMORY	CY62146EV30LL45ZST	1	1	1	1		C	
N	LSI3	10396648	LSI/MEMORY	MX29GL128ELT2I-90G	1	1	1	1		C	
N	Q12,Q13	10399706	TRANSISTOR	DSC500100L	2	2	2	2		X	
	X1	10375016	RESONATOR	7V48080006	1	1	1	1		X	
<b>BACK LIGHT UNIT (including amp, power and console circuit)</b>											
N	2	10399936	BACK LIGHT UNIT	TK-RJM511233*001	1	1	1	1		B	
	J2	35015103	JACK/DC	HEC3110-01-010	1	1	1	1		C	
	J4	10206816	JACK/MIC IN	JY-6314*01-130	1	1	1	1		C	
	J1	10305218	JACK/PHONE	JY-6316B*01-070	1	1	1	1		C	
	J3	10305131	JACK/AUDIO IN	ST-3529B	1	1	1	1		C	
N	VR2	10398245	VARIABLE RESISTOR	F-09KV-CASIO-2	1	1	1	1		B	MIC volume
N	VR3	10407265	VARIABLE RESISTOR	F164KPD-1N-CASIO-4	1	1	1	1		B	MAIN volume
	IC3,IC4	10206677	IC	NJM2068D-D	2	2	2	2		X	
	IC2	10300598	IC	TA8227APL-D12-H-T	1	1	1	1		X	
	IC5	10222381	LSI	ST7066U-0A-QG	1	1	1	1		X	
	IC1	10159709	LSI	UPD65881GK-1019ETA	1	1	1	1		X	
	L2,L5	10231919	COIL	RB53-856396NP	2	2	2	2		X	
	L1,L3,L4,L6	10231920	COIL	RB53-856397NP	4	4	4	4		X	
	Q7	10206835	TRANSISTOR	KTA1046-Y-U/P	1	1	1	1		X	
	X1	10093909	RESONATOR	CSBLA1M00J58-B0	1	1	1	1		X	
	D3,D5	23901820	DIODE	1SS355TE-17	2	2	2	2		X	
	D1,D2	10261170	DIODE	SRT14-A2	2	2	2	2		X	
	D4	23603102	DIODE	UDZSTE-175.1B	1	1	1	1		X	
N	Q2,Q3,Q5, Q6,Q9	10399706	TRANSISTOR	DSC500100L	5	5	5	5		X	
	Q1	10217742	TRANSISTOR	KTA1270-Y-AT/P	1	1	1	1		X	
	Q4	10206675	TRANSISTOR	KTA1273-Y-AT/P	1	1	1	1		X	
	3	10308432	LED	SLR343BD2T3F	2	2	2	2		X	
	4	10123033	REFLECTOR	RJM502534-001V01	1	1	1	1		X	
	5	10122917	BACK LIGHT PLATE	RJM502475-001V01	1	1	1	1		X	
	6	10122970	FILM	RJM502473-001V01	1	1	1	1		X	
	7	10081190	TOP PIECE	RJM501982-001V01	1	1	1	1		X	
	8	10270485	SPONGE/8X75	M441167-001	2	2	2	2		X	
<b>KEYBOARD PCB</b>											
N	9	10399944	PCB UNIT/KYA	TK-RJM508870*003	1	1	1	1		C	KYA1/KYA2
	D801-D952	23153132	DIODE	1SS133T-77	152	152	152	152		X	
<b>PANEL UNIT</b>											
N	10	10399745	DISPLAY PLATE	RJM511158-001V01	1	1	1	1		X	
N	11	10399707	KNOB/ROTARY	M341109-012V01	1	1	1	1		C	
N	12	10399728	CASE/PANEL	RJM511092-001V01	1	1	1	1		X	
N	13	10401543	SHEET/V-ZERO	RJM511424-001V01	1	1	1	1		X	
N	14	10399732	RUBBER BUTTON/A	RJM511119-001V01	1	1	1	1		X	
N	15	10399734	RUBBER BUTTON/B	RJM511120-001V01	1	1	1	1		X	
N	16	10399743	RUBBER BUTTON/C	RJM511133-001V01	1	1	1	1		X	
N	17	10399736	RUBBER BUTTON/D	RJM511122-001V01	1	1	1	1		X	
N	18	10399738	RUBBER BUTTON/E	RJM511123-001V01	2	2	2	2		X	
N	19	10399741	RUBBER BUTTON/P	RJM511125-001V01	1	1	1	1		X	
N	20	10402782	LCD	ZAS-TY012724DN00	1	1	1	1		X	
N	21	10310620	CONNECTOR/LCD	RJM505823-002V01	2	2	2	2		X	

- 1: WK-220\_DI
- 2: WK-220\_EU
- 3: WK-220\_UK
- 4: WK-220\_US

N	Item	Code No.	Parts Name	Specification	Q'ty				Price Code	R	Remarks
					1	2	3	4			
<b>SIDE PANEL UNIT</b>											
N	22	10399756	SPEAKER NET/LEFT	RJM511336*001V01	1	1	1	1		X	
N	23	10399757	SPEAKER NET/RIGHT	RJM511337*001V01	1	1	1	1		X	
	24	69251950	FABRIC TAPE/13X280	M440368-1	2	2	2	2		X	
N	25	10399730	CASE/SIDE/LEFT	RJM511093-001V01	1	1	1	1		X	
N	26	10399731	CASE/SIDE/RIGHT	RJM511094-001V01	1	1	1	1		X	
N	27	10272063	SPEAKER	C12J03	2	2	2	2		X	
N	28	10401520	WIRE/WHITE	1007TASC24450W3030	1	1	1	1		X	for Left speaker (+)
N	29	10401519	WIRE/GREEN	1007TASC24450G3030	1	1	1	1		X	for Left speaker (-)
N	30	69265830	SPONGE/35X260	M440589-001	1	1	1	1		X	for Left speaker wires
	31	10127790	SPONGE/20X40	RJM503059-001V02	4	4	4	4		X	for Speaker wires
N	32	10377008	WIRE/BROWN	1007TASC24850T3030	1	1	1	1		X	for Right speaker (-)
N	33	10377007	WIRE/BLUE	1007TASC24850B3030	1	1	1	1		X	for Right speaker (+)
	34	10135484	SPONGE/30X300	RJM503496-001	1	1	1	1		X	for Right speaker wires
<b>KEYBOARD UNIT</b>											
N	35	10399719	WHITE KEY/SEB	RJM507652*002V01	1	1	1	1		B	
	36	10304687	WHITE KEY/CB	TK-RJM507243*002	5	5	5	5		A	
N	37	10399720	WHITE KEY/CSG	RJM507653*002V01	1	1	1	1		B	
	38	10289648	BLACK KEY/3p	RJM506595-007V02	1	1	1	1		B	
	39	10289646	BLACK KEY/10p	RJM506595-005V02	2	2	2	2		A	
	40	10289649	BLACK KEY/8p	RJM506595-008V02	1	1	1	1		B	
	41	10269450	RUBBER CONTACT/SEB	RJM507649-001V01	1	1	1	1		B	
	42	10269451	RUBBER CONTACT/CB	RJM507656-001V01	5	5	5	5		A	
	43	10269449	RUBBER CONTACT/CSG	RJM507650-001V01	1	1	1	1		B	
<b>MAIN CASE UNIT</b>											
N	44	10399939	CASE UNIT/MAIN	TK-RJM511164*001	1	1	1	1		X	
N	45	10399750	FELT/DAMPER/KEYBOARD	RJM511238-001V01	1	1	1	1		X	
N	46	10406872	FELT/LOWER LIMIT/KEYBOARD	RJM511237-002V01	1	1	1	1		X	
	47	10406873	FABRIC TAPE	RJM511554-001V01	1	1	1	1		X	
N	48	10399748	FELT/UPPER LIMIT/KEYBOARD	RJM511236-001V01	1	1	1	1		X	
	49	10273146	DOUBLE FACED TAPE	RJM507938-001V01	5	5	5	5		X	
	50	10284332	BRACKET/for STAND	M440866-001V02	2	2	2	2		X	
	51	10263726	BATTERY TERMINAL/+	M441101-001V02	1	1	1	1		X	
	52	10263727	BATTERY TERMINAL/-	M441102-001V02	1	1	1	1		X	
	53	10263724	BATTERY TERMINAL/A	M441099-001V02	2	2	2	2		X	
	54	10263725	BATTERY TERMINAL/B	M441100-001V02	3	3	3	3		X	
	55	69268840	FABRIC TAPE/4X10	M440684-1	8	8	8	8		X	
N	56	10399937	BATTERY COVER	TK-M341288*012	1	1	1	1		X	
N	57	10263730	RUBBER FOOT	M441160-001V01	4	4	4	4		X	
	58	10403459	LOWER COVER	RJM507741-002V02	1	1	1	1		X	
N	59	10399747	LOWER COVER	RJM511159-001V01	1	1	1	1		X	
<b>ACCESSORIES</b>											
N	-	10408260	AC ADAPTOR	AD-E95100LU-P2				1		B	
N	-	10399696	AC ADAPTOR	AD-E95100LG-P2		1				B	
N	-	10025472	MUSIC STAND	M141071-1	1	1	1	1		C	



Sub PCB: M829-PSA1 (1/2)

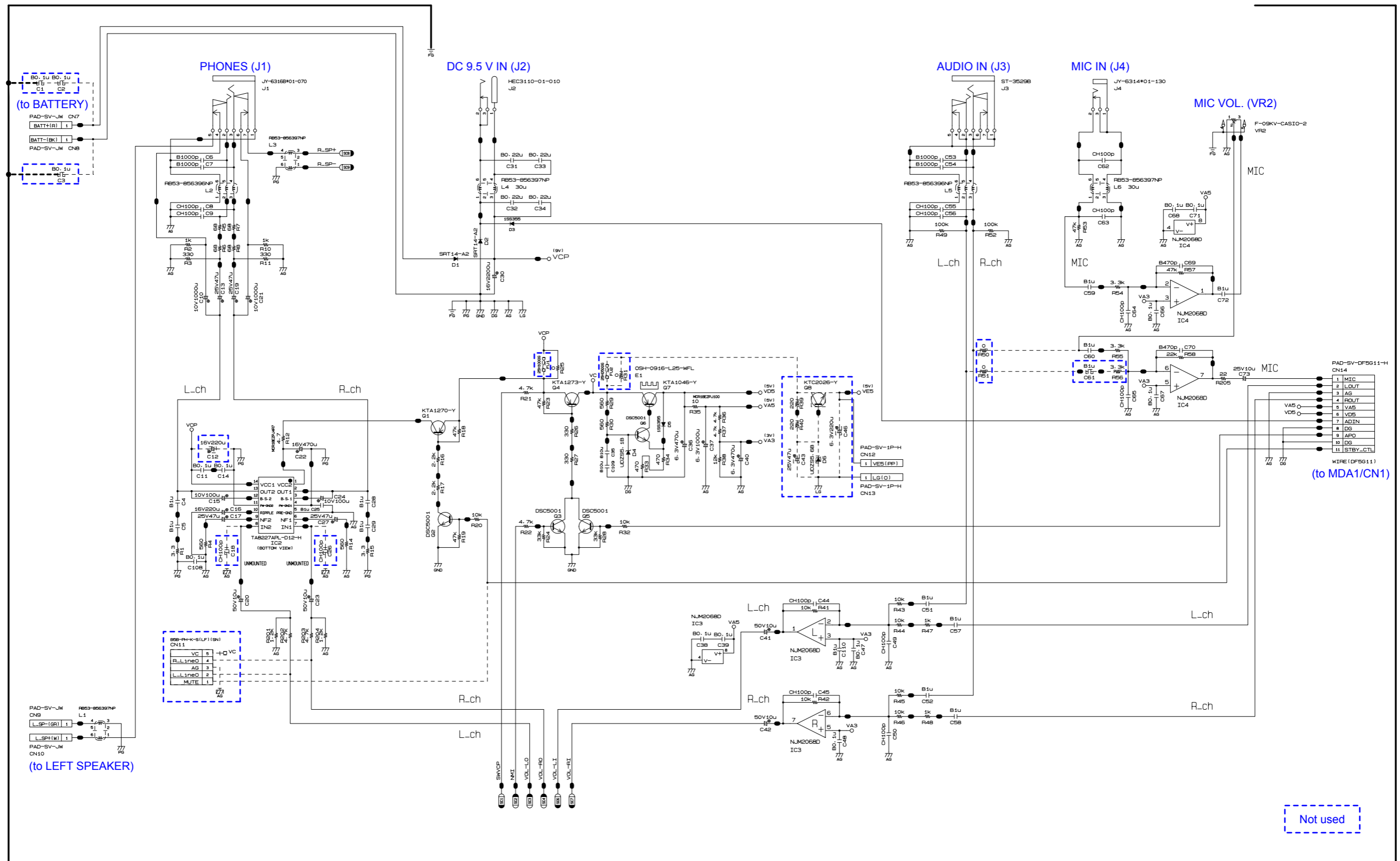

LEFT SPEAKER

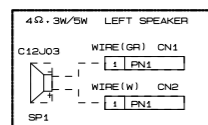

BATTERY

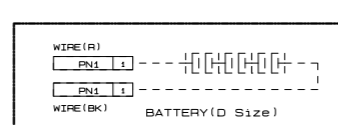

RIGHT SPEAKER

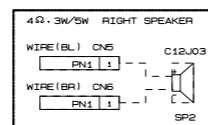



Keyboard PCB: M709-KYA1/KYA2

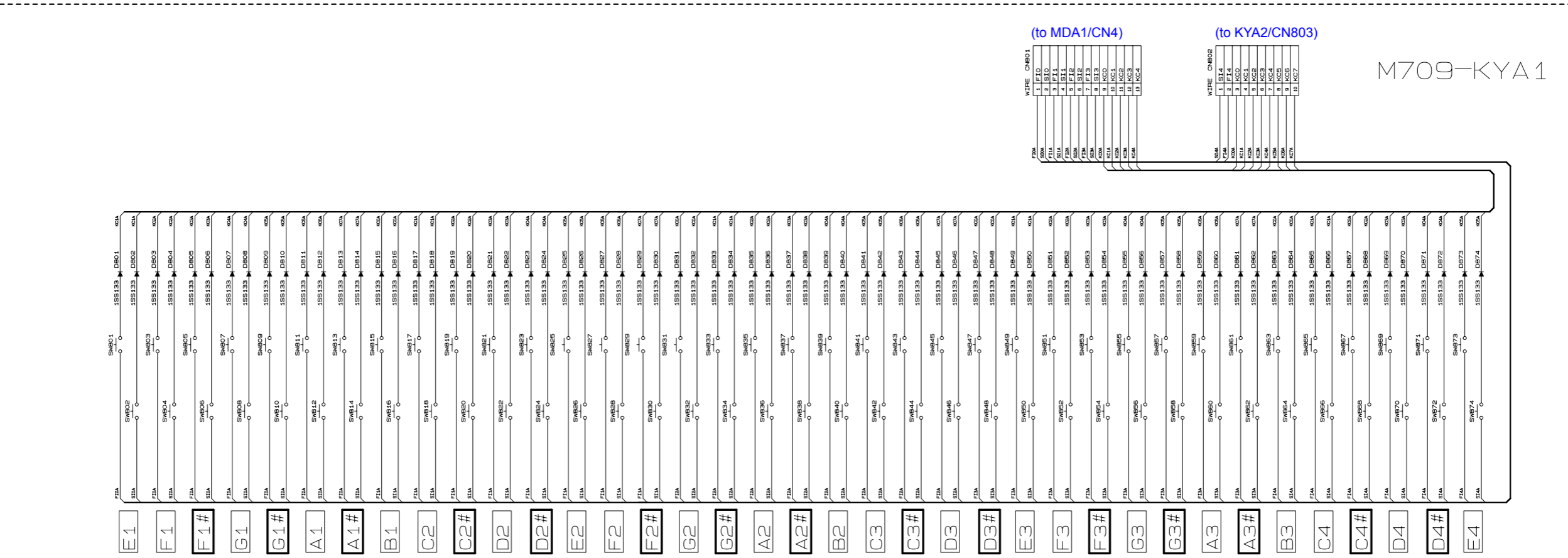
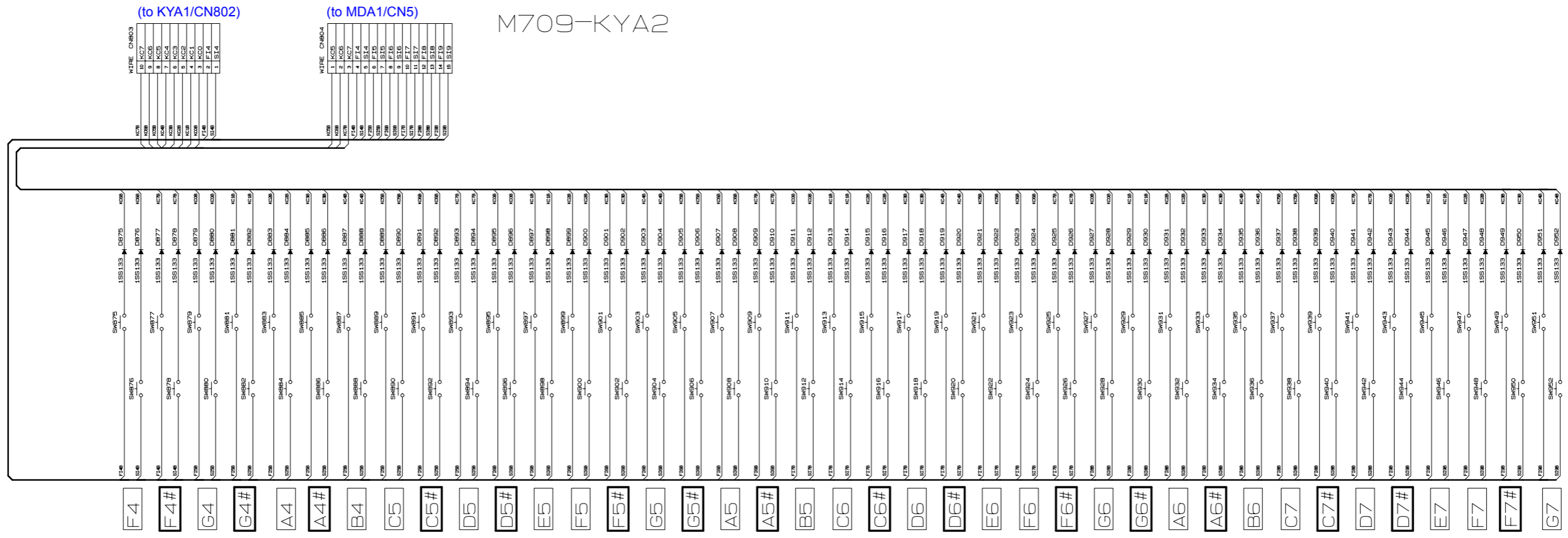

- Ver. 1 : Jul. 2011
- Correction of the CONTENTS
  - Correction of the DISASSEMBLY (P18)
  - Correction of the EXPLODED VIEW (P29 and P30)
  - Correction of the PARTS LIST (P32 and P33)
- Ver. 2 : Jul. 2011
- Correction of the PARTS LIST (P33)
- Ver. 3 : Jul. 2011
- Correction of the PARTS LIST (P33)
- Ver. 4 : Jul. 2014
- Correction of the CIRCUIT DESCRIPTION (P5)

**CASIO COMPUTER CO.,LTD.**  
Overseas Service Division

6-2, Hon-machi 1-Chome  
Shibuya-ku, Tokyo 151-8543, Japan